

 **PLASSON**[®]
Flow Solutions

Catalogue

2024



Celebrating
60 Years
of Innovation

Content

Mechanical Fittings	6-90
Electrofusion Fittings	94-161
Electrofusion Tooling	165-188
Series 1 Fittings	192-236
Silver Line Fittings	241-255



A close-up photograph of two white, cylindrical mechanical fittings. The fittings have a flared top and a series of vertical ridges on their side. They are mounted on a dark, textured metal plate. The background is blurred, showing a greenish-grey color.

 PLASSON

MECHANICAL FITTINGS

Content

MECHANICAL FITTINGS

Compression Fittings for PE pipe	14-41
Conversion & Adaptor Sets from PE to Copper / UPVC / PP / Lead / Galvanised Pipe	42-47
Pipe Conversion Chart	48
Accessories for Compression Fittings	49-55
Fittings for 160mm PE Pipe	56-58
Threaded Outlet Saddles	59-61
Tapping Saddles & Valves	62-64
BSP Threaded Fittings	65-70
Valves	70-79
Quarter Turn Valves	80-83
Technical Specifications	84-85
Installation Instructions for Compression Fittings	86-88
Installation Instructions for Pipe Adaptors Conversion Sets	89-90
Installation Instructions for Plass4 and Copper Pipe Adaptor (Universal Adaptor)	

ACCESORIOS MECÁNICOS

Accesorios Mecánicos para tuberías de PEAD	14-41
Juegos de conversión y adaptadores de PE a Cobre / PVC / PP / Plomo / Tubos galvanizados	42-47
Gráfico de conversiones para tuberías	48
Recambios y Accesorios	49-55
Accesorios para tuberías de PE 160mm	56-58
Collarines / Tomas Simples	59-61
Tomas en carga y Válvulas	62-64
Accesorios roscados (Rosca BSP)	65-70
Válvulas	70-79
Válvulas Quarter Turn	80-83
Detalles técnicos	84-85
Instrucciones de montaje (para accesorios de compresión)	86-88
Instrucciones de montaje (para adaptadores de tubos) Juegos de conversión	89-90
Instrucciones de montaje de Plass4 & tubo de cobre y adaptador Universal	

Compression Fittings

07010 / 87010

Page 14

Coupling
Enlace recto



07610 / 87610

Page 15

Repair Coupling
Enlace recto de reparación



07110 / 87110

Page 16

Reducing Coupling
Enlace Recto Reductor



07020 / 87020

Page 17

Male Adaptor
Enlace mixto rosca macho



07720

Page 18

Male Integral Brass Thread
Enlace mixto rosca macho de latón



07030 / 87030

Page 19

Female Adaptor
Enlace mixto rosca hembra



0703G

Page 20

Female Adaptor G
Enlace mixto rosca hembra G



07320 / 87320

Page 20

Shouldered Adaptor
Adaptador minero



07120 / 87120

Page 21

End Plug
Tapón final



07050 / 87050

Page 22

90° Elbow
Codo de 90°



07510

Page 22

90° Reducing Elbow
Codo de 90° reductor



07850 / 87850

Page 23

90° Elbow with Threaded Male Offtake
Codo de 90° compresión rosca macho



07770

Page 24

90° Elbow with Male Integral Brass
Codo de 90° con macho integral de latón



07150 / 87150

Page 25

90° Elbow with Threaded Female Offtake
Codo de 90° compresión rosca hembra



07060 / 87060

Page 26

45° Elbow
Codo de 45°



07450

Page 26

45° Elbow with Threaded Male Offtake
Codo de 45° compresión rosca macho



07350

Page 27

90° Elbow Adaptor
Codo espiga



07750

Page 27

Wall Plate Elbow
Codo de aplicación mural



07040 / 87040

Page 28

90° Tee
Te de 90°



0704P

Page 29

90° Slip Tee
Te de 90° de reparación



07740

Page 29

90° Enlarging Tee
Te de 90° alargado



07340 / 87340

Page 30

90° Reducing Tee
Te de 90° reductor



07840

Page 31

90° Tee with Threaded
Male Offtake
Te de 90° compresión
rosca macho



0714S0

Page 31

90° Reducing Tee with
Threaded Female Offtake
Te de 90° reducción
compresión rosca hembra



07140 / 87140

Page 32

90° Tee with Threaded
Female Offtake
Te de 90° compresión
rosca hembra



0714P0

Page 33

90° Slip Tee with Threaded
Female Offtake
Te de 90° rosca hembra
de reparación



07810 / 87810

Page 33

Coupling with Riser
Enlace recto con
derivación rosca macho



07640 / 87640

Page 34

45° Tee
Te de 45°



07220 / 87220

Page 35

Compression Flange
Adaptor (with metal flange)
Adaptador compresión-
brida (con brida de metal)



072306 / 872306

Page 36

Flange Adaptor (with
metal flange)
Adaptador espiga-brida
(con brida de metal)



07006

Page 37

Metal Flange
Brida de metal



07250

Page 38

Threaded Adaptor
Adaptador compresión
rosca macho



07270

Page 39

Brass Threaded Adaptor
Adaptador rosca de latón



070170

Page 40

Plass4 (Universal) Coupling
Plass4 Enlace (universal)



070570

Page 40

Plass4 (Universal)
90° Elbow
Plass4 - Codo de 90°
(universal)



07550

Page 41

Y-fitting with Threaded
Male Offtake
Y compresión rosca macho



07540

Page 41

Cross with Threaded Female Offtake
Cruz compresión rosca hembra



0701QQ

Page 46

Coupling for PVC Pipe
Enlace recto para tubo de PVC



Conversion & Adaptor Sets

071209

Page 42

Plug Adaptor
Tapón ciego



077802

Page 46

Conversion Set for Lead Pipe
Juego adaptador para tubos de plomo



07950

Page 42

Pipe Liner for PE SDR 11 Pipe
Refuerzo de tubos



078908

Page 47

Converter Rubber Adaptor for Galvanised Pipe
Convertor de goma para tubos de acero galvanizado



07896

Page 43

Adaptor for Copper and Imperial UPVC
Adaptador para cobre y UPVC



078907

Page 47

Conversion Set Adaptor for Galvanised Pipe
Juego de conversion para tubos de acero galvanizado



Accessories

07930 / 87930

Page 43-44

Reducing Set
Juego reductor



07004 / 87004

Page 49

Nut
Racor



07940

Page 44

Modular Adaptor
Adaptador modular



07002

Page 50

O - Ring NBR
Junta tórica (NBR)



0701C0

Page 44

Copper Pipe Adaptor
Adaptador para tubo de cobre



070029

Page 51

Seal - NBR
Sello de NBR



07970

Page 45

Grip Ring for UPVC and PP Pipe
Casquillo de apriete para tubos de UPVC y PP



87910

Page 52

Seal - EPDM
Sello de EPDM



07438

Page 45

Conversion Set for Copper Pipe
Juego adaptador para tubos de cobre



07003

Page 52

Split Ring - Polyacetal
Casquillo de apriete (acetal)



87003

Page 53

Split Ring - Polyacetal
Casquillo de apriete (acetel)



07003

Page 53

Split Ring - CPVC
Casquilla de apriete (CPVC)



87003V

Page 54

Split Ring - CPVC
Casquilla de apriete (CPVC)



07005 / 87005

Page 54

Insert
Inserto de PP



18960

Page 55

Chamfer Tool for PE Pipes
Herramienta para biselar



07960

Page 55

Chamfer Tool for PE Pipes
Herramienta para biselar



07990

Page 55

PLASSON Wrench
Llave PLASSON



Fittings for 160mm Pipes

070106

Page 56

Coupling
Enlace recto



070406

Page 56

90° Tee
Te de 90°



070506

Page 57

90° Elbow
Codo de 90°



072206

Page 57

Compression Flange
Adaptor (with metal flange)
Adaptador compresión-
brida (con brida de metal)



072306

Page 57

Flange Adaptor (with metal
flange)
Adaptador brida
(con brida de metal)



073206

Page 58

Shouldered Adaptor
Adaptador minero



07006

Page 58

Half Metal Flange
Brida de metal



Threaded Outlet Saddles

16076

Page 59

Saddle Single Outlet with
Reinforcing Ring
Collarin simple con
anillo de refuerzo



16176

Page 60

Saddle Double Outlet with
Reinforcing Ring Options
Collarin doble con
anillo de refuerzo



16005

Page 61

Plated Nut & Bolt for Saddles
Tornillo y tuerca de acero
niquelado para collarin



Tapping Saddles & Valves

18680

Page 61

Mechanical Tapping Valve
Valvula Mecanica con salida
rotatoria Tapper®



16300

Page 63

PLASSADDLE Threaded



16310

Page 64

PLASSADDLE Tapper



1631R

Page 64

PLASSADDLE Tapper Male



BSP Threaded Fittings

050107

Page 65

Threaded Socket
Manguito rosca
hembra x hembra



050207

Page 65

Threaded Reducing Bushing
Manguito reductor
hembra x macho



050407

Page 66

90° Threaded Tee
Te de 90° rosca hembra



050507

Page 66

90° Threaded Elbow
Codo de 90° rosca hembra



051507

Page 67

90° Threaded Elbow
Male x Female
Codo roscado-macho
x hembra



050605

Page 67

Threaded Reducing Nipple
Machón doble reductor



050607

Page 68

Threaded Nipple
Machón doble



050707

Page 68

Threaded Cap
Machón doble



051107

Page 69

Threaded Reducing Socket
Manguito reductor rosca
hembra - hembra



051607

Page 69

Threaded Riser
Espiga roscada



051707

Page 70

Threaded Plug
Tapón rosca macho



Valves

03703

Page 70

Ball Valve
Válvula esférica



0370302

Page 71

PA Ball Valve Female x Male



03405

Page 71

Threaded Stoptap
(Seal NBR)
Válvula de línea rosca
hembra (juntas NBR)



03407

Page 71

Compression Stoptap
(Seal NBR)
Válvula de línea
compresión (juntas NBR)



03048 / 03948

Page 72

Angle Seat Valve (Seal NBR)
Threaded x Compression
Válvula de asiento angular
compresión - rosca
macho - juntas NBR



03047

Page 72

Angle Seat Valve (seal NBR),
Threaded Inlet & Outlet
Válvula de asiento angular
(sello NBR), roscas macho



03049

Page 73

Angle Seat Valve (seal FPM),
Threaded Inlet & Outlet
Válvula de asiento angular
(sello FPM), roscas macho



03046

Page 73

Angle Seat Valve (Seal NBR)
Compression Inlet & Outlet
Válvula de asiento angular,
(sello NBR) compresión



03067 / 03068

Page 74

Check Valve (Seal EPDM)
Threaded Inlet & Outlet
Válvula antirretorno, (sello
EPDM) roscas macho



03801

Page 74

Fix Ratio Pressure
Reducing Valve



0220

Page 74

Universal Pressure
Regulator UPR 550



03039

Page 75

Quick Coupling Valve
(Seal NBR)
Válvula de acople
rápido (juntas NBR)



03139

Page 75

Key for Quick Coupling
Valve 3039
Conexión de acople rápido



03226 / 03227

Page 75

Check Valve Insert
Valvula de control



03589

Page 76

Male Rc thread to G
threaded Free Nut



03510T

Page 76

Water Meter Seat



035100

Page 77

Water Meter Manifold
Soporte para control
de flujo de agua



036010

Page 77

PP Ball Valve
PP Válvula de esfera



036020

Page 78

PP Ball Valve Male Adaptor
PP Válvula de esfera
rosca macho



036030

Page 78

PP Ball Valve Female
Adaptor PP Válvula de
esfera rosca hembra



Quarter Turn Valves

03010

Page 79

Quarter Turn Valve Male
Threaded x Compression
Rosca Macho/ Compression



03012

Page 79

Quarter Turn Valve
Male Threaded
x Female Threaded
Rosca Macho/Rosca Hembra



03017

Page 79

Quarter Turn Valve
Compression x Compression
Compression



Coupling

07010

Enlace recto

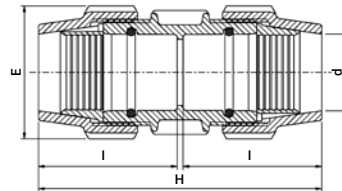

Product Code	Size d x d	E	H	I	UB	UC	W
070106016	16 x 16	39	105	50	10	400	52
070100020	20 x 20	48	122	59	10	200	93
070100025	25 x 25	54	126	61	10	180	116
070100032	32 x 32	64	145	71	5	100	181
070100040	40 x 40	82	177	87	—	75	310
070100050	50 x 50	96	201	98	—	45	457
070100063	63 x 63	113	230	113	—	30	741
070100125	125 x 125	212	460	225	—	3	5347

87010

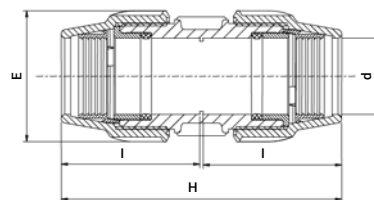

Product Code	Size d x d	E	H	I	UB	UC	W
870100075	75 x 75	132	289	143	—	16	1246
870100090	90 x 90	152	334	164	—	9	1893
870100110	110 x 110	181	398	196	—	5	3321

Repair Coupling

07610

Enlace recto de reparación

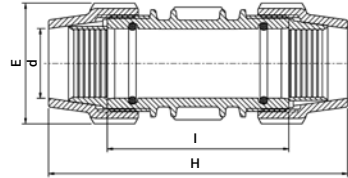

Product Code	Size d x d	E	H	I	UB	UC	W
076100020	20 x 20	48	122	78	10	240	141
076100025	25 x 25	54	136	90	10	150	119
076100032	32 x 32	64	174	120	5	80	202
076100040	40 x 40	82	215	148	—	55	360
076100050	50 x 50	96	244	158	—	30	536
076100063	63 x 63	113	270	170	—	24	836
076100125	125 x 125	212	460	265	—	3	5318

87610

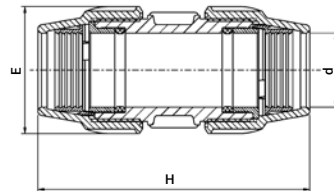

Product Code	Size d x d	E	H	UB	UC	W
876100075	75 x 75	132	289	—	450	1205
876100090	90 x 90	152	334	—	450	1893
876100110	110 x 110	181	398	—	130	3258

Reducing Coupling

07110

Enlace Recto Reductor

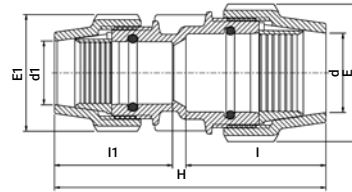

Product Code	Size d x d1	E	E1	H	I	I1	UB	UC	W
071100020016	20 x 16	48	39	111	57	50	10	300	74
071100025016	25 x 16	54	39	113	58	50	10	220	88
071100025020	25 x 20	54	48	119	58	57	10	200	100
071100032020	32 x 20	64	48	140	67	57	5	150	142
071100032025	32 x 25	64	54	133	67	58	5	120	143
071100040025	40 x 25	82	54	156	84	58	—	90	219
071100040032	40 x 32	82	64	156	84	67	—	90	245
071100050025	50 x 25	96	54	176	93	58	—	70	305
071100050032	50 x 32	96	64	175	98	62	—	70	332
071100050040	50 x 40	96	82	184	93	84	—	60	381
071100063025	63 x 25	113	54	193	110	58	—	50	461
071100063032	63 x 32	113	64	197	110	62	—	45	486
071100063040	63 x 40	113	82	208	110	82	—	40	546
071100063050	63 x 50	113	96	214	110	93	—	36	574

87110

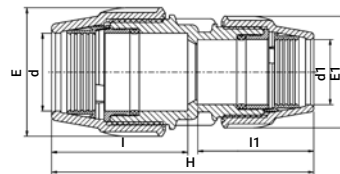

Product Code	Size d x d1	E	E1	H	I	I1	UB	UC	W
871100075050	75 x 50	132	96	250	137	98	—	22	920
871100075063	75 x 63	132	113	257	137	112	—	18	964
871100090063	90 x 63	152	113	291	169	115	—	12	1397
871100090075	90 x 75	152	132	316	169	139	—	10	1663
871100110090	110 x 90	181	152	380	196	161	—	6	2719

Male Adaptor

07020

Enlace mixto rosca macho

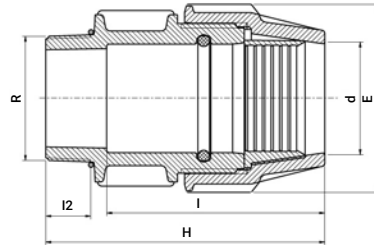

Product Code	Size d x R	E	H	I	I2	UB	UC	W
0702060160030A	16 x 3/8"	39	76	59	13	10	600	33
070206016005	16 x 1/2"	39	79	59	16	10	500	34
070206016007	16 x 3/4"	39	79	59	17	10	500	35
070200020005	20 x 1/2"	48	92	71	17	10	350	58
070200020007	20 x 3/4"	48	92	71	18	10	350	59
070200020010	20 x 1"	48	86	52	20	10	350	60
070200025005	25 x 1/2"	54	94	72	17	10	250	68
070200025007	25 x 3/4"	54	95	72	18	10	250	73
070200025010	25 x 1"	54	97	72	20	10	250	79
070200032007	32 x 3/4"	64	106	83	18	5	150	113
070200032010	32 x 1"	64	107	83	20	5	150	122
070200032013	32 x 1 1/4"	64	110	83	22	5	150	114
070200032015	32 x 1 1/2"	64	110	83	22	5	140	127
070200040010	40 x 1"	82	118	91	20	—	110	184
070200040013	40 x 1 1/4"	82	117	90	22	—	110	185
070200040015	40 x 1 1/2"	82	117	90	22	—	100	185
070200040020	40 x 2"	82	123	91	26	—	100	208
070200050010	50 x 1"	96	133	106	20	—	70	266
070200050013	50 x 1 1/4"	96	136	106	22	—	70	266
070200050015	50 x 1 1/2"	96	136	109	22	—	70	277
070200050020	50 x 2"	96	140	109	26	—	65	284
070200063013	63 x 1 1/4"	113	154	123	22	—	48	443
070200063015	63 x 1 1/2"	113	154	123	22	—	48	451
070200063020	63 x 2"	113	167	123	26	—	48	461
070200063025	63 x 2 1/2"	113	160	123	29	—	45	459

87020

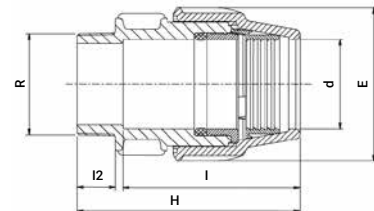

Product Code	Size d x R	E	H	I	I2	UB	UC	W
870200075020	75 x 2"	132	189	156	26	—	28	737
870200075025	75 x 2 1/2"	132	192	156	29	—	28	752
870200075030	75 x 3"	132	196	156	33	—	25	751
870200090020	90 x 2"	152	226	169	26	—	16	1103
870200090025	90 x 2 1/2"	152	229	169	29	—	16	1097
870200090030	90 x 3"	152	232	169	33	—	16	1090
870200090040	90 x 4"	152	238	169	38	—	12	1133
870200110020	110 x 2"	181	263	215	26	—	8	1933
870200110030	110 x 3"	181	259	215	33	—	8	1933
870200110040	110 x 4"	181	267	215	42	—	8	1944

Male Integral Brass Thread

07720

Enlace mixto rosca macho de laton

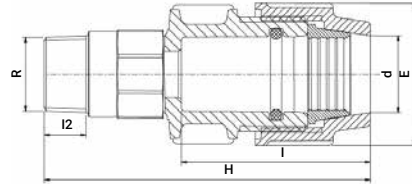

Product Code	Size d x R	E	H	I	I2	UB	UC	W
077200032007	32 x 3/4"	64	139	83	18	1	100	240
077200032010	32 x 1"	64	141	83	20	1	100	276
077200032013	32 x 1 1/4"	64	142	83	22	1	75	300
077200032015	32 x 1 1/2"	64	142	83	22	1	75	330
077200040007	40 x 3/4"	82	149	91	18	1	55	413
077200040010	40 x 1"	82	151	91	20	1	65	413
077200040013	40 x 1 1/4"	82	154	91	22	1	65	428
077200040015	40 x 1 1/2"	82	153	91	22	1	55	428
077200050010	50 x 1"	96	169	106	20	1	45	539
077200050013	50 x 1 1/4"	96	172	106	22	1	45	563
077200050015	50 x 1 1/2"	96	172	106	22	1	45	586
077200063013	63 x 1 1/4"	113	190	123	22	1	30	842
077200063015	63 x 1 1/2"	113	190	123	22	1	30	874
077200063020	63 x 2"	113	194	123	26	1	30	855

Female Adaptor

07030

Enlace mixto rosca hembra

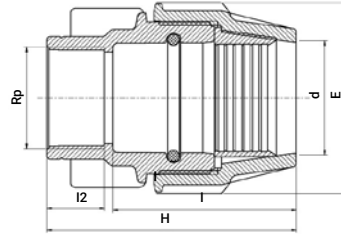

Product Code	Size d x Rp	E	H	I	I2	UB	UC	W
070306016005	16 x 1/2"	39	73	52	19	10	500	36
070306016007	16 x 3/4"	39	75	53	19	10	500	36
070300020005	20 x 1/2"	48	82	60	19	10	350	60
070300020007	20 x 3/4"	48	82	60	19	10	350	58
070300020010	20 x 1"	48	92	57	21	10	300	68
070300025007	25 x 3/4"	54	88	63	21	10	250	83
070300025010	25 x 1"	54	88	63	21	10	250	78
070300032007	32 x 3/4"	64	94	73	19	5	150	107
070300032010	32 x 1"	64	94	69	21	5	150	115
070300032013	32 x 1 1/4"	64	96	67	25	5	140	140
070300040010	40 x 1"	82	112	84	21	—	110	178
070300040013	40 x 1 1/4"	82	114	84	25	—	110	202
070300040015	40 x 1 1/2"	82	114	84	25	—	100	225
070300050013	50 x 1 1/4"	96	123	93	25	—	75	276
070300050015	50 x 1 1/2"	96	123	93	25	—	70	277
070300050020	50 x 2"	96	128	93	30	—	70	294
070300063013	63 x 1 1/4"	113	139	110	25	—	48	417
070300063015	63 x 1 1/2"	113	139	110	25	—	48	438
070300063020	63 x 2"	113	148	110	30	—	48	443

87030

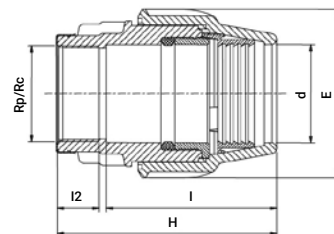

Product Code	Size d x Rp/Rc	E	H	I	I2	UB	UC	W
870300075020	75 x 2"	132	181	137	30	—	27	692
870300075025	75 x 2 1/2"	132	175	137	33	—	27	730
870300090020	90 x 2"	152	212	182	30	—	14	1130
870300090030	90 x 3"	152	222	182	40	—	14	1183
870300090040	90 x 4"	152	242	182	50	—	12	1518
870300110030	110 x 3"	181	263	215	42	—	8	2007
870300110040	110 x 4"	181	273	215	52	—	8	2136

Female Adaptor G

0703G0*

Enlace mixto rosca hembra G

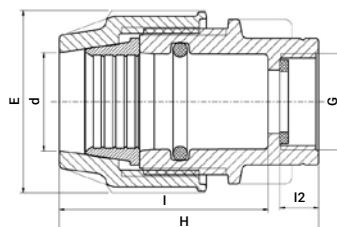

Product Code	Size d x G	E	H	I	I2	UB	UC	W
0703G0025007	25 x 3/4"	54	88	63	12	10	250	83
0703G0025010	25 x 1"	54	88	63	14	10	250	78
0703G0032010	32 x 1"	64	89	72	14	5	150	115

* For connecting parallel male thread | * Para conectar rosca macho paralelo

Shouldered Adaptor

07320

Adaptador minero

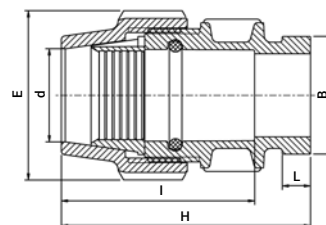

Product Code	Size d x DN (inch)	E	I	L	H	B	UB	UC	W
073200050020	50 x 50 (2")	96	109	16	138	67	—	65	293
073200063020	63 x 50 (2")	113	123	16	156	67	—	45	437

87320

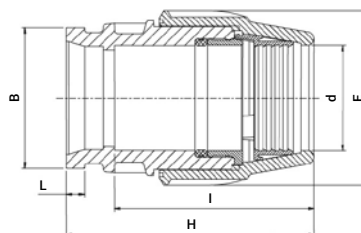

Product Code	Size d x DN (inch)	E	I	L	H	B	UB	UC	W
873200090040	90 x 100 (4")	152	169	16	230	123	—	400	1249
873200110040	110 x 100 (4")	181	215	16	257	123	—	450	1968

End Plug

07120

Tapón final

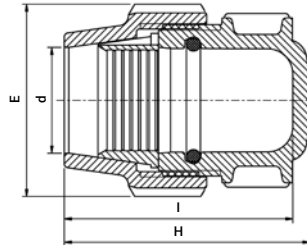

Product Code	Size d	E	H	I	UB	UC	W
071200020	20	48	79	74	10	350	57
071200025	25	54	82	77	10	250	72
071200032	32	64	92	87	5	180	108
071200040	40	82	102	97	—	110	186
071200050	50	96	121	114	—	75	270
071200063	63	113	145	122	—	45	448

87120

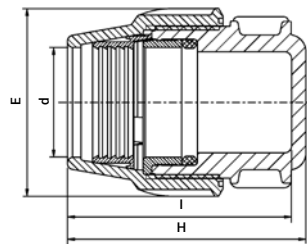

Product Code	Size d	E	H	I	UB	UC	W
871200075	75	132	177	161	—	28	740
871200090	90	152	211	169	—	16	1082
871200110	110	181	234	221	—	10	1924

90° Elbow

07050

Codo de 90°

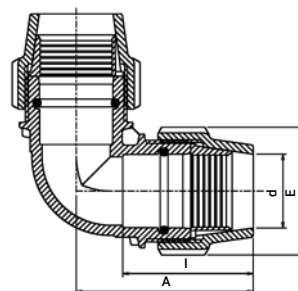

Product Code	Size d x d	E	I	A	UB	UC	W
070506016*	16 x 16	39	50	63	10	350	57
070500020	20 x 20	48	56	73	10	200	95
070500025	25 x 25	54	58	79	10	150	122
070500032	32 x 32	64	67	93	5	100	187
070500040	40 x 40	82	82	108	—	60	341
070500050	50 x 50	96	93	127	—	35	497
070500063	63 x 63	113	110	151	—	24	838

* Only available in black

87050

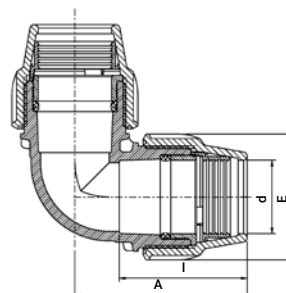

Product Code	Size d x d	E	I	A	UB	UC	W
870500075	75 x 75	132	137	184	—	12	1362
870500090	90 x 90	152	161	216	—	8	2171
870500110	110 x 110	181	196	294	—	4	4005

90° Reducing Elbow

07510

Codo de 90° reductor

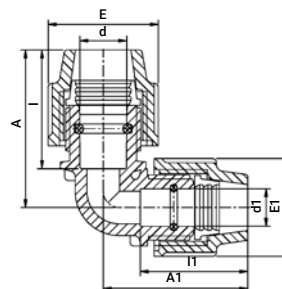

Product Code	Size d x d1	E	E1	I	I1	A	A1	UB	UC	W
075100025020	25 x 20	54	48	58	57	90	75	10	180	114

90° Elbow with Threaded Male Offtake

07850

Codo de 90° compresión rosca macho

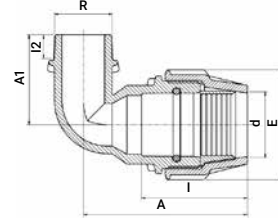

Product Code	Size d x R	E	I	I2	A	A1	UB	UC	W
078500020005	20 x 1/2"	48	57	17	74	41	10	350	55
078500020007	20 x 3/4"	48	57	18	76	43	10	300	64
078500025005	25 x 1/2"	54	58	17	85	47	10	240	70
078500025007	25 x 3/4"	54	58	18	90	48	10	250	79
078500025010	25 x 1"	54	58	20	90	54	10	240	84
078500032007	32 x 3/4"	64	67	18	104	55	5	140	116
078500032010	32 x 1"	64	67	20	104	55	5	140	128
078500032013	32 x 1 1/4"	64	67	22	104	58	5	140	135
078500040010	40 x 1"	82	84	20	124	60	—	90	196
078500040013	40 x 1 1/4"	82	84	22	124	66	—	90	205
078500040015	40 x 1 1/2"	82	84	22	124	66	—	80	220
078500050010	50 x 1"	96	93	20	140	71	—	55	294
078500050013	50 x 1 1/4"	96	93	22	144	74	—	55	335
078500050015	50 x 1 1/2"	96	93	22	144	74	—	55	321
078500050020	50 x 2"	96	93	26	144	76	—	55	373
078500063013	63 x 1 1/4"	113	110	22	168	76	—	35	451
078500063015	63 x 1 1/2"	113	110	22	168	76	—	35	468
078500063020	63 x 2"	113	110	26	170	92	—	35	518

87850

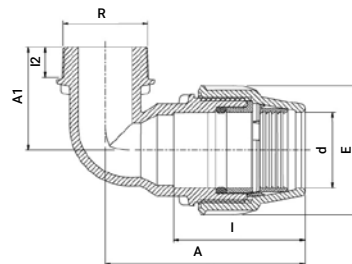

Product Code	Size d x R	E	I	I2	A	A1	UB	UC	W
878500075025	75 x 2 1/2"	132	137	30	207	105	—	24	872
878500075030	75 x 3"	132	137	33	207	110	—	40	934
878500090030	90 x 3"	152	164	33	232	110	—	15	1356
878500110040	110 x 4"	181	196	42	276	140	—	100	2324

90° Elbow with Male Integral Brass

07770

Code de 90° con macho integral de latón

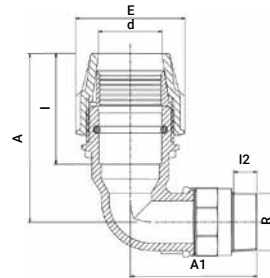

Product Code	Size d x R	E	I	I2	A	A1	UB	UC	W
077700032007	32 x 3/4"	64	67	18	104	79	1	75	270
077700032010	32 x 1"	64	67	20	104	81	1	70	286
077700032013	32 x 1 1/4"	64	67	22	104	82	1	70	343
077700032015	32 x 1 1/2"	64	67	22	104	82	1	70	360
077700040007	40 x 3/4"	82	84	18	124	86	1	55	435
077700040010	40 x 1"	82	84	20	124	88	1	55	435
077700040013	40 x 1 1/4"	82	84	22	124	90	1	55	450
077700040015	40 x 1 1/2"	82	84	22	124	89	1	55	460
077700050010	50 x 1"	96	93	20	144	94	1	40	592
077700050013	50 x 1 1/4"	96	93	22	144	97	1	40	613
077700050015	50 x 1 1/2"	96	93	22	144	97	1	40	613
077700063013	63 x 1 1/4"	113	110	22	168	126	1	27	895
077700063015	63 x 1 1/2"	113	110	22	168	126	1	27	955
077700063020	63 x 2"	113	110	26	170	129	1	27	987

90° Elbow with Threaded Female Offtake

07150

Codo de 90° compresión rosca hembra

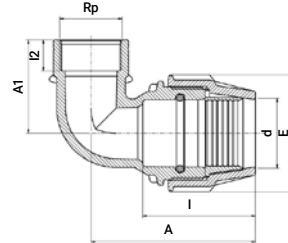

Product Code	Size d x Rp	E	I	I2	A	A1	UB	UC	W
071506016005	16 x 1/2"	39	50	19	66	39	10	500	38
071500020005	20 x 1/2"	48	54	19	78	40	10	350	61
071500020007	20 x 3/4"	48	57	19	78	44	10	300	71
071500025005	25 x 1/2"	54	58	18	81	46	10	250	86
071500025007	25 x 3/4"	54	58	19	81	46	10	250	81
071500025010	25 x 1"	54	58	21	83	50	10	220	90
071500032007	32 x 3/4"	64	67	18	95	54	5	150	143
071500032010	32 x 1"	64	67	21	95	54	5	150	136
071500032013	32 x 1 1/4"	64	67	25	99	60	5	120	167
071500040010	40 x 1"	82	84	21	119	52	—	100	201
071500040013	40 x 1 1/4"	82	84	25	119	62	—	90	246
071500040015	40 x 1 1/2"	82	84	25	119	62	—	80	261
071500040020	40 x 2"	82	84	30	119	75	—	65	293
071500050010	50 x 1"	96	93	21	133	57	—	70	281
071500050013	50 x 1 1/4"	96	93	25	133	67	—	60	313
071500050015	50 x 1 1/2"	96	93	25	135	66	—	60	344
071500050020	50 x 2"	96	93	30	138	85	—	45	387
071500063013	63 x 1 1/4"	113	110	25	162	65	—	35	488
071500063015	63 x 1 1/2"	113	110	25	162	69	—	35	504
071500063020	63 x 2"	113	110	30	160	90	—	35	559

87150

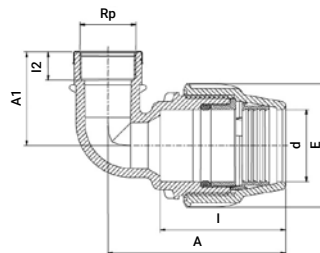

Product Code	Size d x Rp	E	I	I2	A	A1	UB	UC	W
871500075020	75 x 2"	132	137	30	193	100	—	20	860
871500075025	75 x 2 1/2"	132	137	36	196	105	—	18	933
871500075030	75 x 3"	132	137	36	196	105	—	18	982

45° Elbow

07060

Codo de 45°

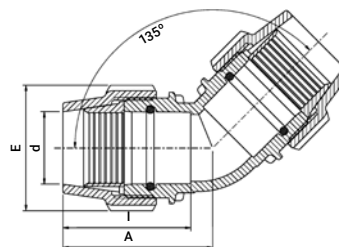

Product Code	Size d x d	E	I	A	UB	UC	W
070600032	32 x 32	64	67	92	5	100	189
070600040	40 x 40	82	84	99	—	60	330
070600050	50 x 50	96	93	110	—	40	476
070600063	63 x 63	113	110	130	—	24	772

87060

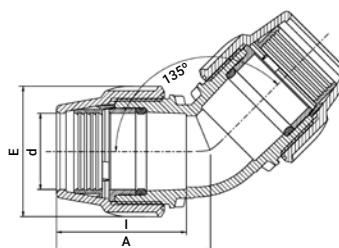

Product Code	Size d x d	E	I	A	UB	UC	W
870600075	75 x 75	132	137	159	—	12	1265
870600090	90 x 90	152	164	194	—	8	2040
870600110	110 x 110	181	196	237	—	4	3558

45° Elbow with Threaded Male Offtake

07450

Codo de 45° compresión rosca macho

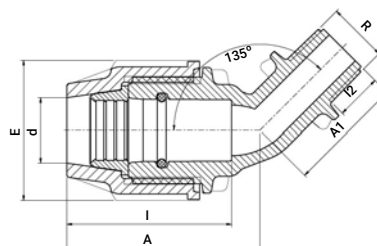

Product Code	Size d x R	E	I	I2	A	A1	UB	UC	W
074500020005	20 x 1/2"	48	57	17	64	40	10	350	54
074500020007	20 x 3/4"	48	57	18	64	41	10	350	55

90° Elbow Adaptor

07350

Codo espiga

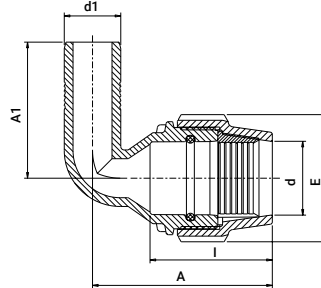

Product Code	Size d x d1	E	I	A	A1	UB	UC	W
073500040040	40 x 40	82	84	118	106	—	80	314
073500040050	40 x 50	82	84	118	120	—	70	275
073500050040	50 x 40	96	93	136	106	—	60	308
073500050050	50 x 50	96	93	136	120	—	55	356
073500063040	63 x 40	113	110	161	106	—	40	450
073500063050	63 x 50	113	110	161	120	—	35	511

Wall Plate Elbow

07750

Codo de aplicación mural

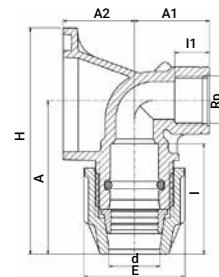

Product Code	Size d x Rp	E	H	I	I2	A	A1	A2	UB	UC	W
077500016005	16 x 1/2"	39	110	50	18	76	40	38	1	150	98
077500020005	20 x 1/2"	48	110	57	18	78	40	38	1	150	92
077500025007	25 x 3/4"	54	120	58	19	81	40	38	1	100	115

90° Tee

07040

Te de 90°

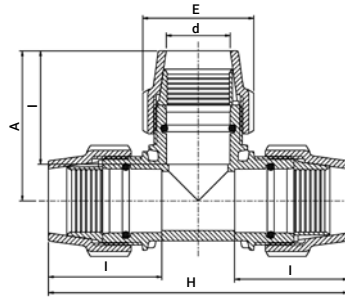

Product Code	Size d x d x d	E	H	I	A	UB	UC	W
070406016	16 x 16 x 16	39	126	50	63	10	220	83
070400020	20 x 20 x 20	48	145	56	73	10	120	141
070400025	25 x 25 x 25	54	156	58	78	5	100	173
070400032	32 x 32 x 32	64	185	67	93	5	60	285
070400040	40 x 40 x 40	82	221	86	111	—	40	501
070400050	50 x 50 x 50	96	252	95	126	—	25	741
070400063	63 x 63 x 63	113	294	110	146	—	16	1215

87040

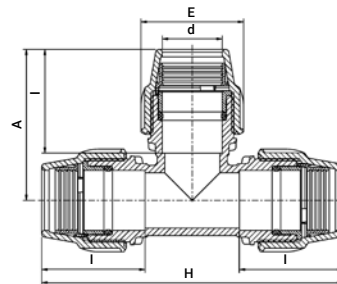

Product Code	Size d x d x d	E	H	I	A	UB	UC	W
870400075	75 x 75 x 75	132	364	137	182	—	8	1947
870400090	90 x 90 x 90	152	438	164	219	—	5	3235
870400110	110 x 110 x 110	181	583	196	294	—	2	5880

90° SlipTee

0704P0

Te de 90° de reparación

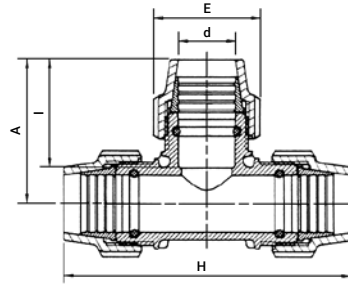

Product Code	Size d x d x d	E	H	I	A	UB	UC	W
0704P0020	20 x 20 x 20	48	145	56	73	10	120	133
0704P0025	25 x 25 x 25	54	156	58	78	5	100	173
0704P0032	32 x 32 x 32	64	185	67	93	5	60	280
0704P0040	40 x 40 x 40	82	221	86	111	—	40	489
0704P0050	50 x 50 x 50	96	252	95	126	—	25	720
0704P0063	63 x 63 x 63	113	294	110	146	—	16	1107

90° Enlarging Tee

07740

Te de alargado

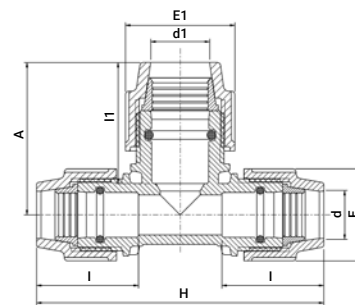

Product Code	Size d x d1 x d	E	E1	H	I	I1	A	UB	UC	W
077400025032	25 x 32 x 25	54	64	156	58	69	87	5	80	220

90° Reducing Tee

07340

Te de 90° reductor

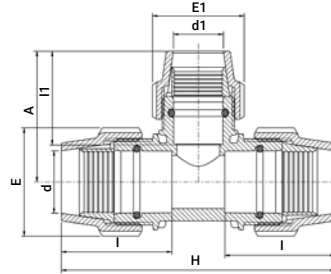

Product Code	Size d x d1 x d	E	E1	H	I	I1	A	UB	UC	W
073400020016	20 x 16 x 20	48	39	137	57	50	70	10	150	125
073400025020	25 x 20 x 25	54	48	150	58	57	74	5	100	166
073400032025	32 x 25 x 32	64	54	173	67	58	83	5	70	256
073400040025	40 x 25 x 40	82	54	205	84	58	84	—	45	412
073400040032	40 x 32 x 40	82	64	207	82	67	97	—	40	428
073400050025	50 x 25 x 50	96	54	228	93	76	105	—	30	550
073400050032	50 x 32 x 50	96	64	230	93	67	117	—	30	590
073400050040	50 x 40 x 50	96	82	236	93	82	114	—	30	647
073400063032	63 x 32 x 63	113	64	268	113	62	118	—	20	892
073400063040	63 x 40 x 63	113	82	268	113	84	139	—	20	962
073400063050	63 x 50 x 63	113	96	275	110	93	132	—	18	1021

87340

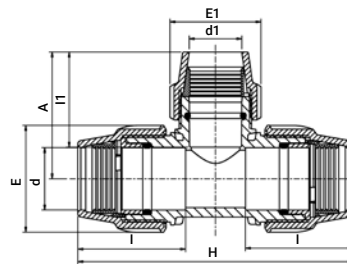

Product Code	Size d x d1 x d	E	E1	H	I	I1	A	UB	UC	W
873400075063	75 x 63 x 75	132	113	364	137	109	153	—	350	1661

90° Tee with Threaded Male Offtake

07840

Te de 90° compresión rosca macho

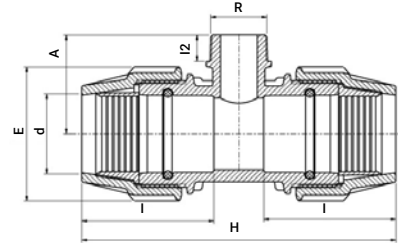

Product Code	Size d x R x d	E	H	I	I2	A	UB	UC	W
078400020005	20 x 1/2" x 20	48	138	56	17	46	10	180	105
078400020007	20 x 3/4" x 20	48	144	56	18	46	10	180	108
078400025005	25 x 1/2" x 25	54	146	58	17	48	5	140	134
078400025007	25 x 3/4" x 25	54	146	58	18	50	5	140	137
078400032010	32 x 1" x 32	64	170	67	20	58	5	80	218
078400040013	40 x 1 1/4" x 40	82	205	84	22	71	—	50	373
078400040015	40 x 1 1/2" x 40	82	205	84	22	71	—	50	376
078400050013	50 x 1 1/4" x 50	96	230	93	22	77	—	36	511
078400050015	50 x 1 1/2" x 50	96	230	93	22	77	—	36	523
078400050020	50 x 2" x 50	96	230	93	26	82	—	36	523
078400063013	63 x 1 1/4" x 63	113	268	113	22	79	—	20	821
078400063015	63 x 1 1/2" x 63	113	268	113	22	83	—	20	828
078400063020	63 x 2" x 63	113	272	110	26	92	—	20	877

90° Reducing Tee with Threaded Female Offtake

0714S0

Te de 90° reducción compresión rosca hembra

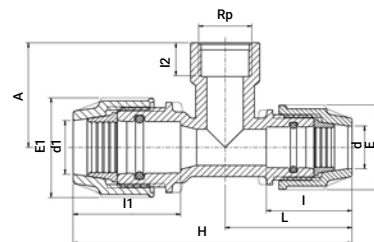

Product Code	Size d x Rp x d1	E	E1	H	L	I	I1	I2	A	UB	UC	W
0714S0020016	20 x 3/4" x 16	48	39	132	69	52	50	19	42	10	180	86
0714S0025020	25 x 3/4" x 20	54	48	139	70	53	52	22	42	5	140	145
0714S0032025	32 x 1" x 25	64	54	169	91	67	58	22	58	5	80	176

90° Tee with Threaded Female Offtake

07140

Te de 90° compresión rosca hembra

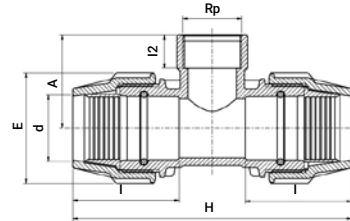

Product Code	Size d x Rp x d	E	H	I	I2	A	UB	UC	W
071406016005	16 x 1/2" x 16	39	122	50	17	42	10	240	66
071406016007	16 x 3/4" x 16	39	122	50	19	41	10	240	65
071400020005	20 x 1/2" x 20	48	144	56	18	42	10	180	104
071400020007	20 x 3/4" x 20	48	144	56	19	45	10	180	110
071400025005	25 x 1/2" x 25	54	151	58	18	45	5	140	131
071400025007	25 x 3/4" x 25	54	151	58	19	48	5	140	140
071400025010	25 x 1" x 25	54	158	58	21	53	5	100	140
071400025013	25 x 1 1/4" x 25	54	158	58	25	64	5	80	194
071400032007	32 x 3/4" x 32	64	177	67	19	51	5	80	210
071400032010	32 x 1" x 32	64	177	67	21	54	5	80	213
071400032013	32 x 1 1/4" x 32	64	182	67	25	65	5	60	253
071400032015	32 x 1 1/2" x 32	64	182	67	25	71	5	60	268
071400040010	40 x 1" x 40	82	203	84	21	61	—	60	357
071400040013	40 x 1 1/4" x 40	82	217	84	24	70	—	55	403
071400040015	40 x 1 1/2" x 40	82	217	84	25	70	—	50	413
071400040020	40 x 2" x 40	82	217	84	30	78	—	45	435
071400050015	50 x 1 1/2" x 50	96	244	93	25	76	—	36	575
071400050020	50 x 2" x 50	96	244	93	30	80	—	30	590
071400063013	63 x 1 1/4" x 63	113	268	113	27	95	—	20	886
071400063015	63 x 1 1/2" x 63	113	268	113	27	95	—	20	898
071400063020	63 x 2" x 63	113	272	110	30	95	—	20	903

87140

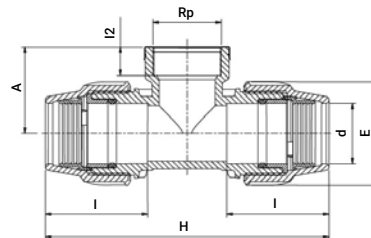

Product Code	Size d x Rp x d	E	H	I	I2	A	UB	UC	W
871400075020	75 x 2" x 75	132	370	137	30	110	—	9	1517
871400075025	75 x 2 1/2" x 75	132	342	134	35	85	—	9	1570
871400075030	75 x 3" x 75	132	370	137	36	110	—	9	1627
871400090030	90 x 3" x 90	152	418	164	41	116	—	7	2351
871400110040	110 x 4" x 110	181	516	200	52	140	—	4	4197

90° Slip Tee with Threaded Female Offtake

0714P0

Te de 90° roscas hembra de reparación

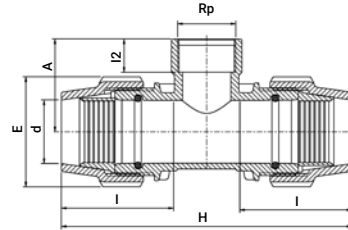

Product Code	Size d x Rp x d	E	H	I	I2	A	UB	UC	W
0714P0040010	40 x 1" x 40	82	203	84	21	61	—	60	361
0714P0050015	50 x 1 1/2" x 50	96	244	93	25	76	—	36	587
0714P0063013	63 x 1 1/4" x 63	113	268	113	27	95	—	20	860

Coupling with Riser

07810

Enlace recto con derivación rosca macho

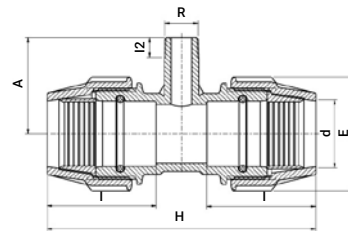

Product Code	Size d x R x d	E	H	I	I2	A	UB	UC	W
078100040007	40 x 3/4" x 40	82	215	89	18	85	5	50	366
078100050007	50 x 3/4" x 50	96	244	98	18	90	5	36	512
078100050010	50 x 1" x 50	96	244	98	20	90	5	36	551
078100063007	63 x 3/4" x 63	113	270	110	18	95	—	24	822
078100063010	63 x 1" x 63	113	270	110	20	95	—	24	820

87810

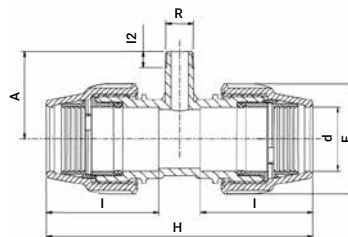

Product Code	Size d x R x d	E	H	I	I2	A	UB	UC	W
878100075007	75 x 3/4" x 75	132	324	137	18	105	—	100	1300
878100075010	75 x 1" x 75	132	324	137	20	105	—	70	1310

45° Tee

07640

Te de 45°

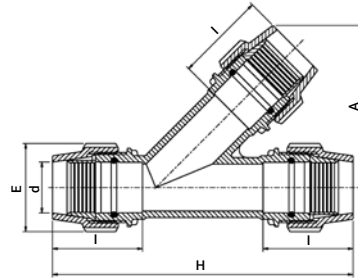

Product Code	Size d x d x d	E	H	I	A	UB	UC	W
076400063	63 x 63 x 63	113	374	110	207	—	10	1432

87640

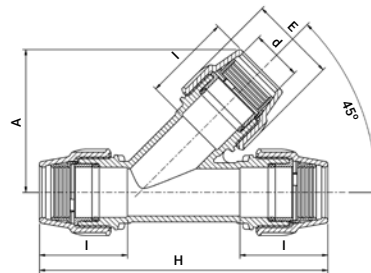

Product Code	Size d x d x d	E	H	I	A	UB	UC	W
876400075	75 x 75 x 75	132	446	137	204	—	130	2500
876400090	90 x 90 x 90	152	519	164	233	—	40	3600
876400110	110 x 110 x 110	181	630	196	284	—	120	6012

Compression Flange Adaptor (with Metal Flange)

07220*

Adaptador compresión-brida (con brida de metal)

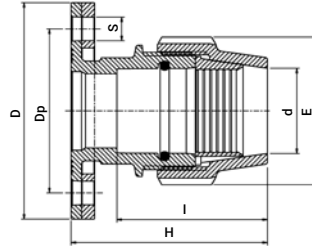

Product Code	Size d x DN (inch)	E	H	I	D	Dp	S	No. of Holes	Metal-Flange Size	UC	W
072200040015	40 x 40 (1 1/2")	82	119	93	150	110	18	4	40 x 40	20	1200
072200050015	50 x 40 (1 1/2")	96	128	93	150	110	18	4	50 x 40	20	1213
072200050020	50 x 50 (2")	96	128	93	165	125	18	4	50 x 50	15	1517
072200063020	63 x 50 (2")	113	145	110	165	125	18	4	63 / 75 x 50	15	1563
072200125050	125 x 125 (5")	212	270	250	250	210	22	8	125 / 160 x 125	4	5550
072200125060	125 x 150 (6")	212	270	250	285	240	22	8	125 / 160 x 150	3	7037

* 072210 - Compression Flange Adaptor without metal flange | * 072210 - Sin brida de metal

87220*

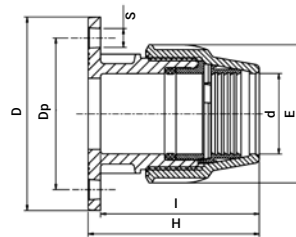

Product Code	Size d x DN (inch)	E	H	I	D	Dp	S	No. of Holes	Metal-Flange Size	UC	W
872200075025	75 x 65 (2 1/2")	132	169	157	185	145	18	4	75 / 90 x 65	12	2200
872200090030	90 x 80 (3")	152	194	182	200	160	18	8	90 / 110 x 80	10	2429
872200090040	90 x 100 (4")	152	194	182	220	180	18	8	90 x 100	8	2980
872200110040	110 x 100 (4")	181	237	224	220	180	18	8	110 x 100	8	3402

* 872210 - Compression flange adaptor without metal flange | * 872210 - Sin brida de metal

Flange Adaptor (with Metal Flange)

072306*

Adaptador espiga-brida (con brida de metal)

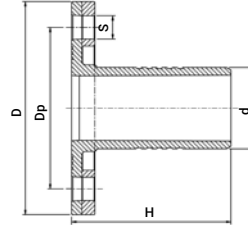

Product Code	Size d x DN (inch)	H	D	Dp	S	No. of Holes	Metal-Flange Size	UC	W
0723060500150A	50 x 40 (1 1/2")	99	150	110	18	4	50 x 40	20	1064
0723060500200A	50 x 50 (2")	99	165	125	18	4	50 x 50	20	1396
0723060630200A	63 x 50 (2")	124	165	125	18	4	63 / 75 x 50	18	1293
0723060630250A	63 x 65 (2 1/2")	124	185	145	18	4	63 x 65	15	1880

* 072301 - Flange adaptor without metal flange | * 072301 - Sin brida de metal

872306*

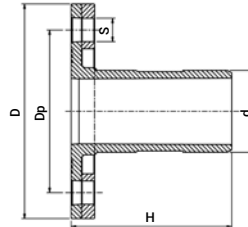

Product Code	Size d x DN (inch)	H	D	Dp	S	No. of Holes	Metal-Flange Size	UC	W
872306075020	75 x 50 (2")	142	165	125	18	4	63 / 75 x 50	15	1402
872306075025	75 x 65 (2 1/2")	142	185	145	18	4	75 / 90 x 65	15	1568
872306075030	75 x 80 (3")	142	200	160	18	8	75 x 80	450	1981
872306090025	90 x 65 (2 1/2")	175	185	145	18	4	75 / 90 x 65	400	1754
872306090030	90 x 80 (3")	175	200	160	18	8	90 / 110 x 80	400	1858
872306090040	90 x 100 (4")	175	220	180	18	8	90 x 100	400	2180
872306110030	110 x 80 (3")	210	200	160	18	8	90 / 110 x 80	450	2019
872306110040	110 x 100 (4")	210	220	180	18	8	100 x 100	400	2329
872306110050	110 x 125 (5")	214	250	210	18	8	110 x 125	360	3987

* 872301 - Flange adaptor without metal flange | * 872301 - Sin brida de metal

Metal Flange

07006

Brida de metal

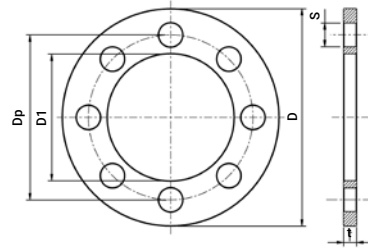

Product Code	Size d x DN (inch)	D	Dp	D1	S	t	Th* (mm)	Th* (inch)	No. of Holes	UC	W
070060050015P	50 x 40 (1 1/2")	150	110	82	18	10	M16	5/8	4	20	844
070060050020P	50 x 50 (2")	165	125	82	18	10	M16	5/8	4	20	1141
070060075020P	63 / 75 x 50 (2")	165	125	96	18	10	M16	5/8	4	20	986
070060063025P	63 x 65 (2 1/2")	185	145	96	18	10	M16	5/8	4	20	1420
070060075025P	75 / 90 x 65 (2 1/2")	185	145	112	18	10	M16	5/8	4	20	1350
070060075030P	75 x 80 (3")	200	160	112	18	10	M16	5/8	8	15	1430
070060090030P	90 / 110 x 80 (3")	200	160	132	18	10	M16	5/8	8	15	1215
070060090040P	90 x 100 (4")	220	180	132	18	10	M16	5/8	8	15	1720
070060110040P	110 x 100 (4")	220	180	151	18	10	M16	5/8	8	15	1416
070060110050P	110 x 125 (5")	250	210	151	18	10	M16	5/8	8	15	2850

* Nominal diameter of bolts | * Diametro nominal del tornillo

Threaded Adaptor

07250*

Adaptador compresión rosca macho

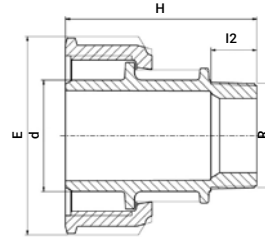

Product Code	Size d x R	E	H	I2	UB	UC	W
072500025005	25 x 1/2"	54	79	17	1	200	36
072500025007	25 x 3/4"	54	80	18	1	200	36
072500032005	32 x 1/2"	64	85	17	1	180	66
072500032007	32 x 3/4"	64	86	18	1	180	65
072500032010	32 x 1"	64	87	20	1	180	68
072500040010	40 x 1"	82	99	20	1	130	108
072500040013	40 x 1 1/4"	82	100	22	1	130	112
072500040015	40 x 1 1/2"	82	100	22	1	130	113
072500050010	50 x 1"	96	102	20	1	80	147
072500050013	50 x 1 1/4"	96	104	24	1	80	154
072500050015	50 x 1 1/2"	96	104	24	1	80	156
072500050020	50 x 2"	96	107	27	1	80	158
072500063010	63 x 1"	113	108	20	1	60	228
072500063013	63 x 1 1/4"	113	111	22	1	60	230
072500063015	63 x 1 1/2"	113	111	22	1	60	230
072500063020	63 x 2"	113	114	26	1	60	258
072500063025	63 x 2 1/2"	113	116	29	1	60	250
072500075015	75 x 1 1/2"	132	128	22	1	30	404
072500075020	75 x 2"	132	132	26	1	30	402
072500075025	75 x 2 1/2"	132	134	29	1	30	412
072500075030	75 x 3"	132	137	33	1	30	430

* Threaded Adaptor Body Cat. No. 078901. Threaded Adaptor Nut - Cat. No. 078940

* Cuerpo del adaptador roscado - Cat. No. 078901. Racor para el adaptador roscado - Cat. No. 078940

Brass Threaded Adaptor

07270

Adaptador rosca de latón

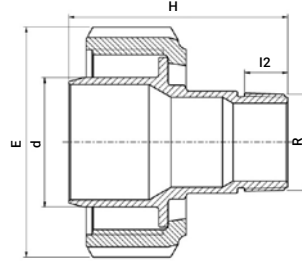

Product Code	Size d x R	E	H	I2	UB	UC	W
072700032010	32 x 1"	64	77	19	1	50	279
072700040010	40 x 1"	82	81	19	1	50	363
072700040013	40 x 1 1/4"	82	90	21	1	50	487
072700050013	50 x 1 1/4"	96	95	21	1	30	523
072700050015	50 x 1 1/2"	96	97	21	1	30	554
072700063013	63 x 1 1/4"	113	105	21	1	20	767
072700063020	63 x 2"	113	112	25	1	20	985

Plass4 (Universal) Coupling

070170

Plass4 Enlace (universal)

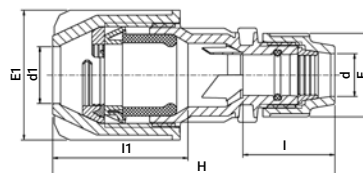

Product Code	Size d x d1	E	E1	H	I	I1	UB	UC	W
070170020027	20 x 20 - 27	48	71	169	57	85	1	80	206
070170025022	25 x 15 - 22	54	64	165	58	80	1	90	183
070170025027	25 x 20 - 27	54	71	170	58	85	1	80	216
070170025035	25 x 27 - 35	54	83	180	58	90	1	60	281
070170032027	32 x 20 - 27	64	71	180	67	85	1	70	240
070170032035	32 x 27 - 35	64	83	195	67	90	1	60	312
070170050050	50 x 35 - 50	96	121	270	93	125	1	20	901

Plass4 (Universal) 90° Elbow

070570

Plass4 - Codo de 90° (universal)

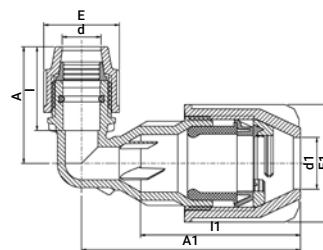

Product Code	Size d x d1	E	E1	I	I1	A	A1	UB	UC	W
070570025022	25 x 15 - 22	54	64	58	105	81	128	1	80	198
070570025027	25 x 20 - 27	54	71	58	105	81	139	1	80	238
070570025035	25 x 27 - 35	54	83	58	112	81	153	1	60	305

Y-Fitting with Threaded Male Offtake

07550

Y compresión rosca macho

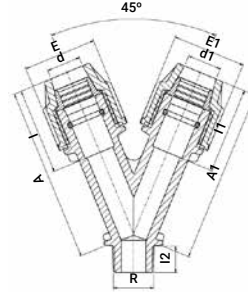

Product Code	Size d x d1 x R	E	E1	I	I1	I2	A	A1	UB	UC	W
075506016007	16 x 16 x 3/4"	39	39	50	50	18	100	100	10	200	75
075500020016	20 x 16 x 3/4"	48	39	57	50	18	108	105	10	180	103
075500020007	20 x 20 x 3/4"	48	48	57	57	18	114	114	10	120	130
075500025007	25 x 25 x 3/4"	54	54	58	58	18	125	125	5	100	154

* In this case diameter should read: d x d x G | * En este caso el diametro debe leido: d x d x G

Cross with Threaded Female Offtake

07540

Cruz compresión rosca hembra

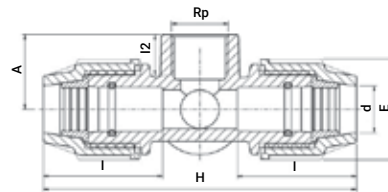

Product Code	Size d x d x d x d x Rp	E	H	I	I2	A	UB	UC	W
075400020007	20 x 20 x 20 x 20 x 3/4"	48	149	57	21	35	5	80	204

Plug Adaptor

071209

Tapón ciego

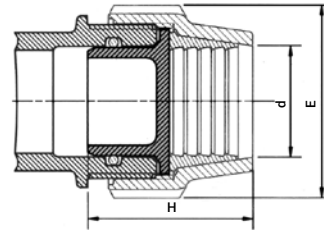

Product Code	Size d	E	H	UB	UC	W
071209020	20	48	47	10	1800	5
071209025	25	54	51	10	1500	8
071209032	32	64	56	10	1000	15
071209040	40	82	66	10	720	24
071209050	50	96	80	10	400	41
071209063	63	113	96	10	200	76

Pipe Liner for PE SDR 11 Pipe

07950

Refuerzo de tubos

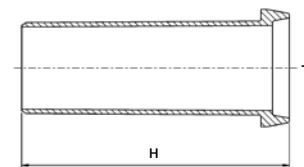

Product Code	Size d *	H	UB	UC	W
079500020	20 x 1.9	63	10	2520	5
079500025	25 x 2.3	63	10	1680	10
079500032	32 x 3.0	79	10	920	13
079500040	40 x 3.7	97	10	480	25
079500050	50 x 4.6	106	10	240	45
079500063	63 x 5.8	125	5	110	72

* O.D. of pipe x wall thickness of pipe | * Diametro externo del tubo x espesor del tubo

Adaptor for Copper and Imperial UPVC

07896*

Adaptador para cobre y PVCU

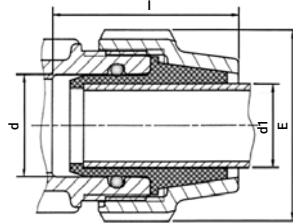

Product Code	Size d x d1	E	I	UB	UC	W
07896015P	20 x 15	48	66	25	1500	15
07896022P	25 x 22	54	64	20	1200	15
07896028P	32 x 28	64	74	20	700	27
07896035P	40 x 35	82	92	10	240	54
07896042P	50 x 42	96	105	10	160	111

* No Pull-Out Resistance | * Sin resistencia a la tracción

Reducing Set

07930

Juego reductor

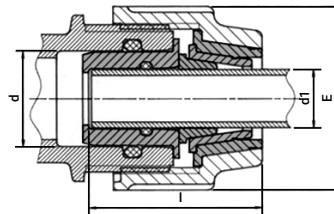

Product Code	Size d x d1	E	I	UB	UC	W
079300025020	25 x 20	54	56	-	300	23
079300032020	32 x 20	64	62	-	300	38
079300032025	32 x 25	64	60	-	250	35
079300040020	40 x 20	82	73	-	180	62
079300040025	40 x 25	82	69	-	180	81
079300040032	40 x 32	82	77	-	200	62
079300050025	50 x 25	96	85	-	120	114
079300050032	50 x 32	96	87	-	120	112
079300050040	50 x 40	96	85	-	120	97
079300063025	63 x 25	113	103	-	80	217
079300063032	63 x 32	113	102	-	80	214
079300063040	63 x 40	113	103	-	80	202
079300063050	63 x 50	113	105	-	80	187
879300075063	75 x 63	132	121	-	40	220
079300110063	110 x 63	181	131	-	24	705

87930

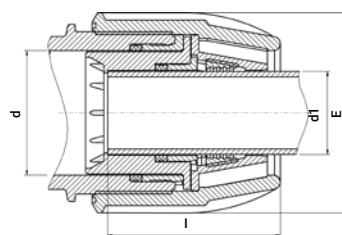

Product Code	Size d x d1	E	I	UB	UC	W
879300075063	75 x 63*	132	121	1	40	220
079300110063	110 x 63	181	131	1	24	705
879300110075	110 x 75	181	145	1	15	655
879300110090	110 x 90	181	154	1	140	671

* Assembled without the inserts

Modular Adaptor

07940

Adaptador modulado

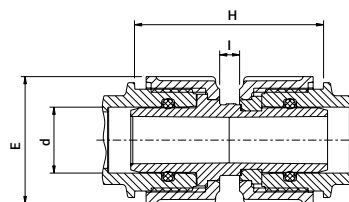

Product Code	Size d	E	H	I	UB	UC	W
079400020	20	48	80	10	10	300	50
079400025	25	54	80	10	10	250	61
079400032	32	64	93	10	5	180	104
079400040	40	82	102	10	5	100	173
079400050	50	93	107	10	—	70	257
079400063	63	113	119	10	—	45	422

Copper Pipe Adaptor

0701C0

Adaptador para tubo de cobre

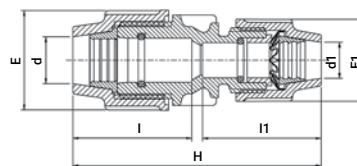

Product Code	Size d (PE) x d1 (Cu)	E	E1	H	I	I1	UB	UC	W
0701C0020005	20 x 15	48	39	115	56	54	—	200	103
0701C0025015	25 x 15	54	39	124	55	54	—	180	86
0701C0025022	25 x 22	54	54	136	60	71	—	150	132
0701C0032028	32 x 28	64	64	150	70	77	—	100	204

Grip Ring for UPVC and PP pipe

07970

Casquillo de apriete para tubos de UPVC y PP



Product Code	Size d	UB	UC	W
07970020	20	–	10000	1
07970025	25	–	10000	2
07970032	32	–	10000	3
07970040	40	–	1000	6
07970050	50	–	1000	10
07970063	63	–	1000	17

Conversion Set for Copper Pipe (Europe + UK dimensions) 07438

Juego adaptador para tubos de cobre



Product Code	Size d x d1	E	I	UB	UC	W
07438015	20 x 15	48	67	10	360	20
07438016	25 x 15	54	69	10	360	29
07438022	25 x 22	54	67	10	360	25
07438028	32 x 28	64	77	10	300	27
07438035	40 x 35	82	92	10	300	38
07438042	50 x 42	96	105	10	250	64
07438054	63 x 54	113	121	1	150	102

Conversion Set for Copper Pipe (CTS dimensions)

Product Code	Size d x d1	E	I	UB	UC	W
07439204	20 x 1/2" (O.D. 15.8mm)	48	67	10	600	20
07439257	25 x 3/4" (O.D. 22.2mm)	54	69	10	500	33

Conversion Set for Copper Pipe (Austalian AS1432 dimensions)

Product Code	Size d x d1	E	I	UB	UC	W
07439205	20 x 15 (1/2") (O.D. 12.7mm)	48	67	10	600	20
07439251	25 x 20 (3/4") (O.D. 19.5mm)	54	69	10	500	33
07439257	25 x 25 (1") (O.D. 25.4mm)	54	69	10	500	33

Coupling for PVC Pipe

0701QQ

Enlace recto para tubo de PVC

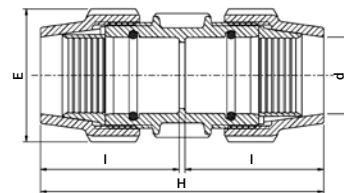

Product Code	Size d x d	E	H	I	UB	UC	W
0701QQ090	90 x 90	154	335	165	—	10	1898
0701QQ110	110 x 110	181	393	194	—	5	3129
0701QQ125	125 x 125	212	460	225	—	3	5347

Conversion Set for Lead Pipe

077802

Juego adaptador para tubos de plomo

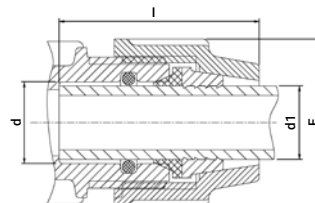

Product Code	Size d x d1	E	I	UB	UC	W
077802025003	25 x 3/8" 5 LB	54	67	5	1000	15
077802025005	25 x 1/2" 7 LB	54	64	5	1500	8
077802032005	32 x 1/2" 9 LB	64	77	5	500	24
077802032007	32 x 3/4" 9 LB	64	76	5	1000	13
077802040007	40 x 3/4" 11 LB	82	95	5	400	42
077802050010	50 x 1" 16 LB	96	104	5	250	68

Converter Rubber Adaptor for Steel and Galvanized Pipe 078908*

Conversor de goma para tubos de acero galvanizado

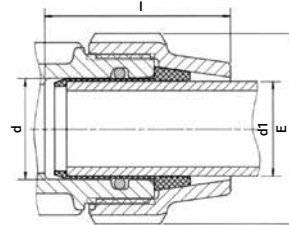

Product Code	Size d x d1	E	I	UB	UC	W
078908010	40 x 1"	82	89	5	200	60
078908013	50 x 1 1/4"	96	98	5	150	89
078908015	50 x 1 1/2"	96	90	5	150	35
078908020	63 x 2"	113	108	5	120	71

* Without pullout resistance | * Extraccion sin resistencia

Conversion Set Adaptor for Steel and Galvanised Pipe 078907

Juego de conversion para tubos de acero galvanizado

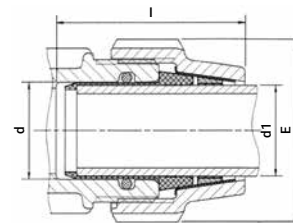

Product Code	Size d x d1	E	I	UB	UC	W
078907010	40 x 1"	82	96	5	200	117
078907013	50 x 1 1/4"	96	105	5	150	150
078907015	50 x 1 1/2"	96	115	5	150	125
078907020	63 x 2"	113	117	5	100	226

Pipe Conversion Chart

Metric PE / Metric U-PVC / Metric PP / Galvanised Steel / Lead Pipe / Imperial U-PVC/Copper

PE métrico / PP y PVCU métrico / Acero galvanizado / Plomo / U-PVC imperial / Cobre...

The basic fitting is a dedicated product for joining metric PE pipe. It will securely join the pipe without any additional components. The fittings can be easily converted for use with other materials simply by adding a conversion set. PLASSON offers a full range of conversion sets to provide exceptional adaptability.

El accesorio PLASSON es un producto dedicado a conectar tuberías de HDPE sin componentes adicionales, con la máxima seguridad. Los accesorios pueden ser convertidos fácilmente a cualquier tipo de tubería usando un juego de conversión acorde. PLASSON ofrece una gama amplia que permite una adaptabilidad excepcional.

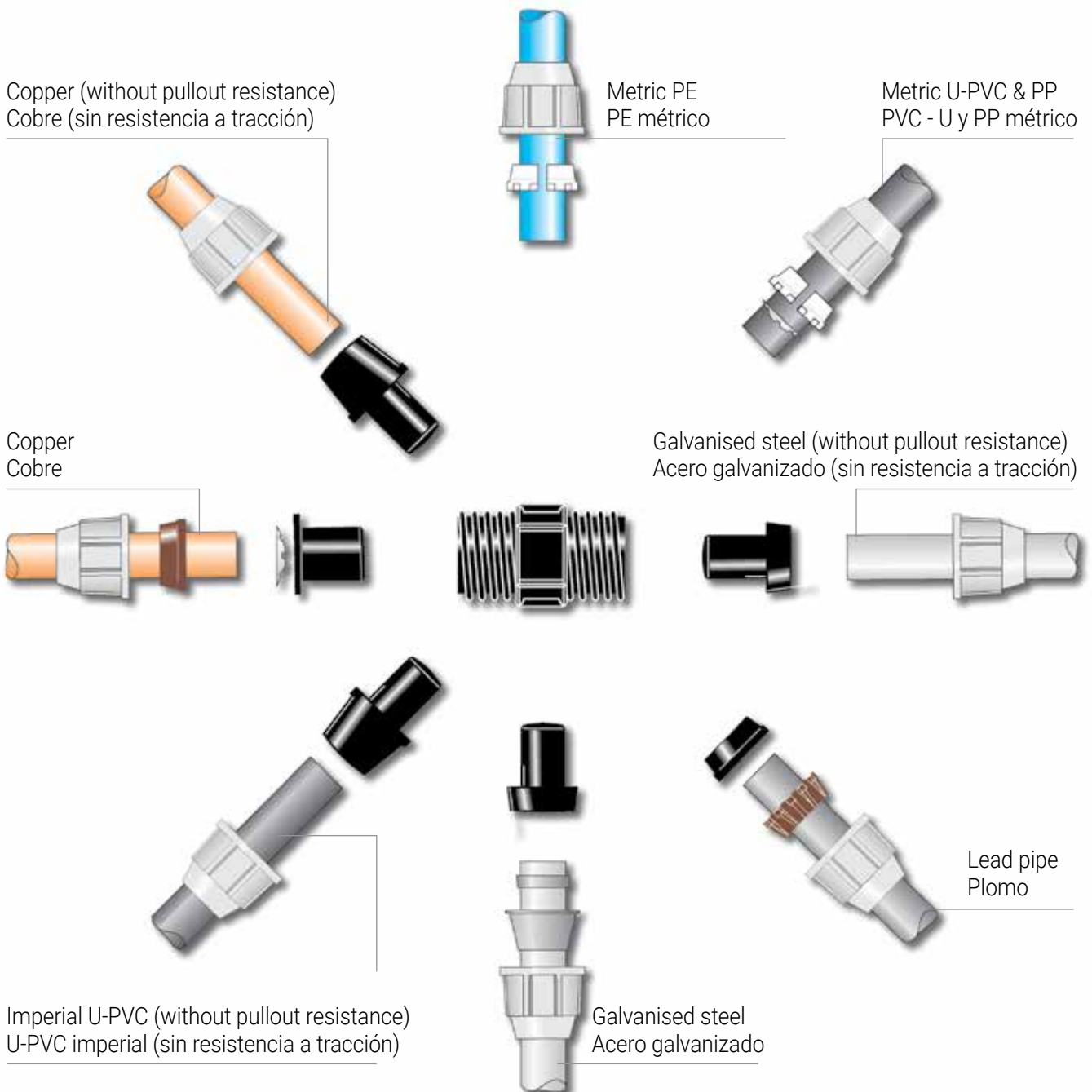

Nut

07004

Racor

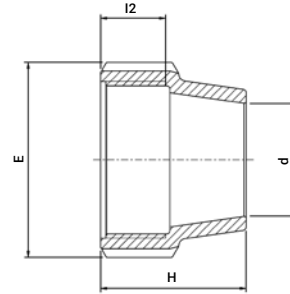

Product Code	Size d	E	H	I2	UB	UC	W
070046016P	16	39	40	23	10	1000	12
070040020P	20	48	45	26	10	700	22
070040025P	25	54	46	26	10	500	26
070040032P	32	64	51	30	5	300	41
070040040P	40	82	63	34	—	200	70
070040050P	50	96	71	34	—	125	104
070040063P	63	113	89	43	—	100	171
070040125P	125	212	185	107	—	10	1135

87004

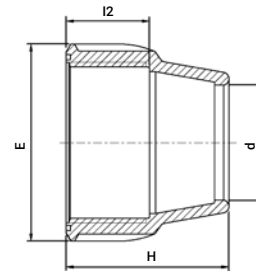

Product Code	Size d	E	H	I2	UB	UC	W
870040075P	75	132	110	56	—	45	293
870040090P	90	153	135	73	—	30	467
870040110P	110	181	170	97	—	16	832

O - Ring NBR

07002

Junta tórica (NBR)

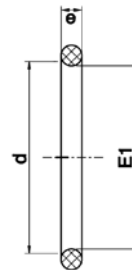

Product Code	Size d	E1	e	UB	UC	W
070020016	16	15	3	—	30000	1
070020020	20	19	3	—	32000	1
070020025	25	24	4	—	12000	1
070020032	32	31	5	—	10000	2
070020040 *	40	39	6	—	4000	5
070020050 *	50	49	7	—	2500	8
070020063 *	63	62	7	—	2000	10
070020075	75	74	8	—	1600	16
070020090	90	89	8	—	1500	17
070020110	110	108	9	—	900	27
070020125	125	122	10	—	700	50
070020160	160	158	12	—	16000	74

* Only for slip repair coupling and tee

O - Ring EPDM (Blue Mark)

07002D0

Junta tórica EPDM, (marca azul)

Product Code	Size d	E1	e	UB	UC	W
07002D016	16	15	3	—	30000	1
07002D020	20	19	3	—	16000	1
07002D025	25	24	4	—	16000	1
07002D032	32	31	5	—	8000	2
07002D075	75	74	8	—	1600	16
07002D090	90	89	8	—	1400	17
07002D110	110	108	9	—	900	27

O - Ring Viton FPM (White Mark)

07002V0

Junta tórica FPM, (marca blanca)

Product Code	Size d	E1	e	UB	UC	W
03050905	16	15	3	—	30000	2
07002V020	20	19	3	—	32000	2
07002V025	25	24	4	—	16000	2
07002V032	32	31	5	—	8000	4
07002V040 *	40	39	6	—	4000	7
07002V050 *	50	49	7	—	2500	12
07002V063 *	63	62	7	—	2000	15
07002V075	75	74	8	—	1600	23
07002V090	90	89	8	—	1400	28
07002V110	110	108	9	—	900	43

* Only for slip repair coupling and tee

Seal - NBR

070029

Sello de NBR

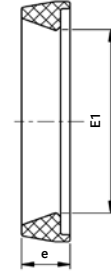

Product Code	Size d	E1	e	UB	UC	W
070029040	40	38	8	50	2600	4
070029050	50	49	9	50	1600	8
070029063	63	62	9	50	1500	9

Seal EPDM (Blue Mark)

07002D9

Sello EPDM, (marca azul)

Product Code	Size d	E1	e	UB	UC	W
07002D940	40	38	8	20	4000	4
07002D950	50	49	9	20	2500	7
07002D963	63	62	9	20	2000	9

Seal Viton FPM (White Mark)

07002V9

Sello de Viton FPM, (marca blanca)

Product Code	Size d	E1	e	UB	UC	W
07002V940	40	38	8	20	4000	7
07002V950	50	49	9	20	2500	12
07002V963	63	62	9	20	2000	14

Seal - EPDM

87910

Sello de EPDM

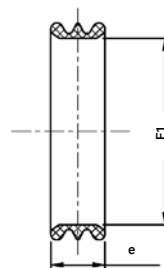

Product Code	Size d	E1	e	UB	UC	W
87910075	75	77	22	10	80	24
87910090	90	92	22	10	50	18
87910110	110	112	24	10	120	27

Seal Viton FPM (White Mark)

87920

Sello de Viton FPM, (marca blanca)

Product Code	Size d	E1	e	UB	UC	W
87920075	75	77	22	10	100	23
87920090	90	92	22	10	70	28
87920110	110	112	24	10	24	43

Split Ring - Polyacetal

07003

Casquillo de apriete (acetal)

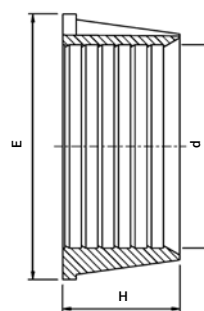

Product Code	Size d	E	H	UB	UC	W
070030016P	16	23	12	100	12000	1
070030020P	20	31	13	100	6500	3
070030025P	25	36	13	100	4500	4
070030032P	32	44	19	50	2000	7
070030040P	40	55	24	50	1200	12
070030050P	50	67	30	20	500	25
070030063P	63	83	37	10	300	46
070030125P	125	161	72	—	35	291

Split Ring - Polyacetal

87003

Casquillo de apriete (acetal)

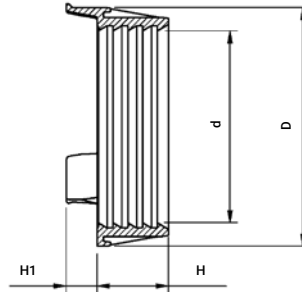

Product Code	Size d	D	H	H1	UB	UC	W
870030075P	75	99	30	14	—	300	53
870030090P	90	115	34	16	—	170	76
870030110P	110	140	42	19	—	100	133

Split Ring - CPVC

07003V

Casquilla de apriete (CPVC)

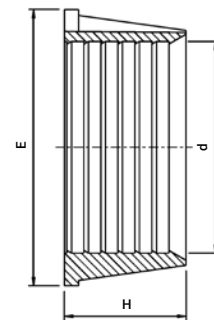

Product Code	Size d	E	H	UB	UC	W
07003V016P	16	23	12	100	12000	3
07003V020P	20	31	13	100	6500	4
07003V025P	25	36	13	100	4500	5
07003V032P	32	44	19	50	1500	11
07003V040P	40	55	24	—	1200	19
07003V050P	50	67	30	—	500	32
07003V063P	63	83	37	—	300	53

Split Ring - CPVC

87003V

Casquilla de apriete (CPVC)

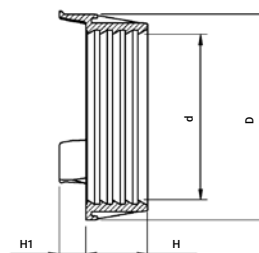

Product Code	Size d	D	H	H1	UB	UC	W
87003V075P	75	99	30	13	—	240	53
87003V090P	90	115	34	14	—	115	90
87003V110P	110	140	42	16	—	70	151

Insert

07005

Inserto de PP

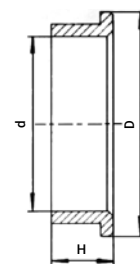

Product Code	Size d	D	H	UB	UC	W
070050016P	16	17	12	100	8700	1
070050020P	20	29	10	100	5000	1
070050025P	25	36	11	100	4000	3
070050032P	32	45	11	100	4000	6
070050075P	75	94	17	—	300	31
070050090P	90	116	25	—	160	56
070050110P	110	138	30	—	100	81
070050125P	125 Upper	164	48	—	80	153
070051125P	125 Lower	142	18	—	160	204

87005



Product Code	Size d	D	H	UB	UC	W
870050075P	75	77	27	—	300	37
870050090P	90	92	31	—	200	48
870050110P	110	113	40	—	100	80

Chamfer Tool for PE Pipes

18960

Herramienta para biselar



Product Code	Size	UB	UC	W
189600063020P	20 - 63	–	180	202

Chamfer Tool for PE Pipes

07960

Herramienta para biselar



Product Code	Size	UB	UC	W
079600063020	20 - 63	1	180	86

PLASSON Wrench

07990

Llave PLASSON



Product Code	Size	UB	UC	W
07990001	16 - 40	–	250	65
07990005	40 - 75	–	75	296
07990000	63 - 125	–	40	840

Coupling

070106

Enlace recto

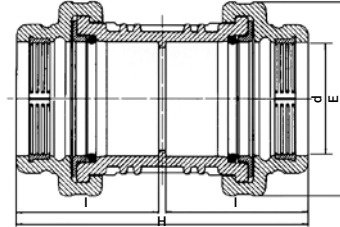

Product Code	Size d x d	E	I	H	UB	UC	W
0701061600A	160 x 160	280	204	418	—	2	8888

Repair Coupling

076106

Enlace recto de reparación

Product Code	Size d x d	E	I	H	UB	UC	W
0761061600A	160 x 160	280	204	418	—	2	9170

90° Tee

070406

Te de 90°

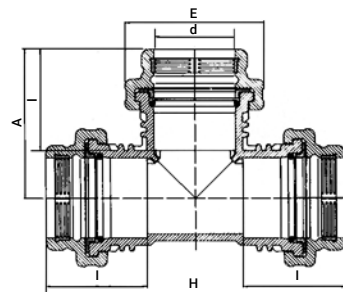

Product Code	Size d x d x d	E	I	H	A	UB	UC	W
0704061600A	160 x 160 x 160	280	204	601	301	—	1	14738

90° Elbow

070506

Codo de 90°

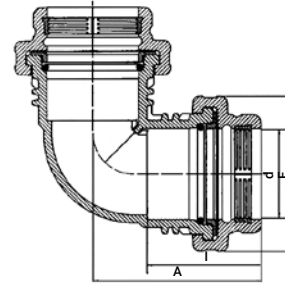

Product Code	Size d x d	E	I	A	UB	UC	W
0705061600A	160 x 160	280	204	301	—	2	10008

Compression Flange Adaptor (with Metal Flange)

072206

Adaptador compresión-brida (con brida de metal)

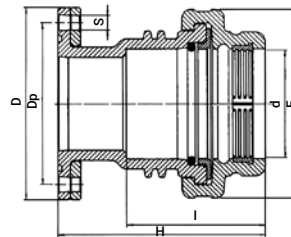

Product Code	Size d x DN (inch)	E	H	I	D	Dp	S	No. of Holes	Metal-Flange Size	UC	W
0722061600500A	160 x 125 (5")	280	304	204	250	210	18	8	125 / 160 x 125	3	7700
0722061600600A	160 x 150 (6")	280	304	204	285	240	22	8	125 / 160 x 150	3	9151

Flange Adaptor (with Metal Flange)

072306

Adaptador brida (con brida de metal)

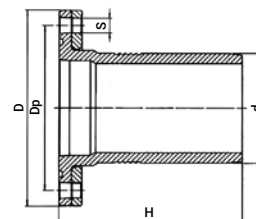

Product Code	Size d x DN (inch)	H	D	Dp	S	No. of Holes	Metal-Flange Size	UC	W
0723061600500A	160 x 125 (5")	265	250	210	18	8	125 / 160 x 125	6	4345
0723061600600A	160 x 150 (6")	265	285	240	22	8	125 / 160 x 150	5	5650

Shouldered Adaptor

073206

Adaptador minero

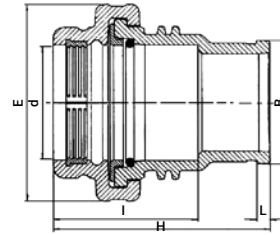

Product Code	Size d x DN (inch)	E	H	I	L	B	UB	UC	W
0732061600600A	160 x 150 (6")	280	304	204	18	175	—	4	5170

Half Metal Flange

07006

Brida de metal

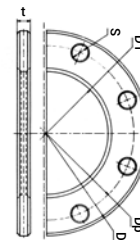

Product Code	Size d x DN (inch)	D	Dp	D1	S	t	Th* (mm)	Th* (inch)	No. of Holes	UC	W
070060160050P	125 / 160 x 125 (5")	250	210	170	18	12	M16	5/8	4	1100	—
070060160060P	125 / 160 x 150 (6")	250	240	170	22	12	M20	3/4	4	1800	—

* Nominal diameter of bolts | * Diametro nominal del tornillo

Saddle Single Outlet with Reinforcing Ring

16076*

Collarin simple con anillo de refuerzo

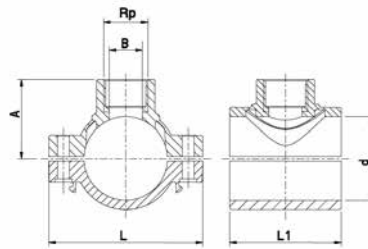

Product Code	Size d x Rp	B	L	L1	A	No. of Bolts	UB	UC	W
160760020005	20 x 1/2"	10	70	45	33	2	1	400	63
160760025005	25 x 1/2"	15	75	50	36	2	1	300	70
160760025007	25 x 3/4"	15	75	50	37	2	1	300	73
160760032005	32 x 1/2"	16	92	60	40	2	1	150	133
160760032007	32 x 3/4"	19	92	60	41	2	1	150	135
160760032010	32 x 1"	20	92	60	42	2	1	150	142
160760040005	40 x 1/2"	16	92	60	45	2	1	150	141
160760040007	40 x 3/4"	19	92	60	46	2	1	150	143
160760040010	40 x 1"	25	92	60	49	2	1	150	151
160760050005	50 x 1/2"	16	106	73	51	2	1	100	179
160760050007	50 x 3/4"	21	106	73	52	2	1	100	180
160760050010	50 x 1"	25	106	73	54	2	1	100	187
160760050013	50 x 1 1/4"	25	106	73	58	2	1	100	212
160760063005	63 x 1/2"	16	116	84	58	4	1	70	278
160760063007	63 x 3/4"	20	116	84	59	4	1	70	279
160760063010	63 x 1"	25	116	84	61	4	1	70	286
160760063013	63 x 1 1/4"	32	116	84	66	4	1	70	308
160760063015	63 x 1 1/2"	39	116	84	67	4	1	60	322
160760075005	75 x 1/2"	16	122	98	64	4	1	60	369
160760075007	75 x 3/4"	20	122	98	65	4	1	55	369
160760075010	75 x 1"	25	122	98	67	4	1	55	376
160760075013	75 x 1 1/4"	32	122	98	72	4	1	55	398
160760075015	75 x 1 1/2"	40	122	98	73	4	1	50	411
160760075020	75 x 2"	40	122	98	78	4	1	45	433
160760090005	90 x 1/2"	16	141	105	72	4	1	40	453
160760090007	90 x 3/4"	20	141	105	73	4	1	40	454
160760090010	90 x 1"	25	141	105	75	4	1	40	460
160760090013	90 x 1 1/4"	32	141	105	80	4	1	40	483
160760090015	90 x 1 1/2"	40	141	105	81	4	1	40	467
160760090020	90 x 2"	50	141	105	86	4	1	40	511
160760110005	110 x 1/2"	16	165	116	83	4	1	45	561
160760110007	110 x 3/4"	20	165	116	84	4	1	45	562
160760110010	110 x 1"	25	165	116	87	4	1	36	567
160760110013	110 x 1 1/4"	32	165	116	91	4	1	36	588
160760110015	110 x 1 1/2"	40	165	116	92	4	1	36	600
160760110020	110 x 2"	50	165	116	97	4	1	30	615
160760125007	125 x 3/4"	20	184	124	91	6	1	30	762
160760125010	125 x 1"	25	184	124	94	6	1	30	755
160760125013	125 x 1 1/4"	32	184	124	98	6	1	30	778
160760125015	125 x 1 1/2"	40	184	124	99	6	1	30	781
160760125020	125 x 2"	50	184	124	104	6	1	25	796
160760140010	140 x 1"	25	201	136	101	6	1	24	893
160760140013	140 x 1 1/4"	32	201	136	106	6	1	24	912
160760140015	140 x 1 1/2"	40	201	136	107	6	1	24	922
160760140020	140 x 2"	50	201	136	112	6	1	20	938
160760160010	160 x 1"	25	223	145	112	6	1	20	1039
160760160013	160 x 1 1/4"	32	223	145	117	6	1	20	1061
160760160015	160 x 1 1/2"	40	223	145	118	6	1	20	1071
160760160020	160 x 2"	50	223	145	123	6	1	20	1080
160760180010	180 x 1"	25	245	154	122	6	1	16	1314
160760180013	180 x 1 1/4"	32	245	154	127	6	1	16	1319
160760180015	180 x 1 1/2"	40	245	154	128	6	1	16	1349
160760180020	180 x 2"	50	245	154	133	6	1	16	1334

16086 - without reinforcing ring, 16077 - With stainless steel bolts

Saddle Double Outlet with Reinforcing Ring Options

16176*

Collarin doble con anillo de refuerzo

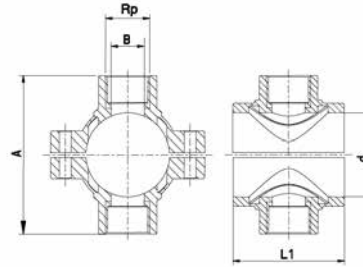

Product Code	Size d x Rp	B	L	L1	A	No. of Bolts	UB	UC	W
161760020005	20 x 1/2"	10	70	45	66	2	1	300	73
161760025005	25 x 1/2"	15	75	50	71	2	1	250	81
161760025007	25 x 3/4"	15	75	50	73	2	1	250	86
161760032005	32 x 1/2"	16	92	60	80	2	1	140	144
161760032007	32 x 3/4"	19	92	60	82	2	1	140	148
161760032010	32 x 1"	20	92	60	84	2	1	140	163
161760040005	40 x 1/2"	16	92	60	89	2	1	120	153
161760040007	40 x 3/4"	19	92	60	91	2	1	120	157
161760040010	40 x 1"	25	92	60	98	2	1	120	174
161760050005	50 x 1/2"	16	106	73	102	2	1	80	193
161760050007	50 x 3/4"	21	106	73	104	2	1	80	196
161760050010	50 x 1"	25	106	73	109	2	1	80	210
161760050013	50 x 1 1/4"	25	106	73	117	2	1	80	260
161760063005	63 x 1/2"	16	116	84	116	4	1	80	293
161760063007	63 x 3/4"	20	116	84	118	4	1	70	296
161760063010	63 x 1"	25	116	84	123	4	1	70	310
161760063013	63 x 1 1/4"	32	116	84	132	4	1	70	354
161760063015	63 x 1 1/2"	39	116	84	133	4	1	60	382
161760075005	75 x 1/2"	16	122	98	128	4	1	60	382
161760075007	75 x 3/4"	20	122	98	130	4	1	60	382
161760075010	75 x 1"	25	122	98	135	4	1	50	397
161760075013	75 x 1 1/4"	32	122	98	144	4	1	50	438
161760075015	75 x 1 1/2"	40	122	98	145	4	1	50	465
161760075020	75 x 2"	40	122	98	155	4	1	40	513
161760090005	90 x 1/2"	16	141	105	143	4	1	45	467
161760090007	90 x 3/4"	20	141	105	146	4	1	45	468
161760090010	90 x 1"	25	141	105	151	4	1	45	482
161760090013	90 x 1 1/4"	32	141	105	160	4	1	40	526
161760090015	90 x 1 1/2"	40	141	105	162	4	1	40	546
161760090020	90 x 2"	50	141	105	172	4	1	36	585
161760110005	110 x 1/2"	16	165	116	166	4	1	40	575
161760110007	110 x 3/4"	20	165	116	168	4	1	40	577
161760110010	110 x 1"	25	165	116	173	4	1	36	586
161760110013	110 x 1 1/4"	32	165	116	182	4	1	30	628
161760110015	110 x 1 1/2"	40	165	116	187	4	1	30	653
161760110020	110 x 2"	50	165	116	196	4	1	24	685
161760125007	125 x 3/4"	20	184	124	182	6	1	20	814
161760125010	125 x 1"	25	184	124	187	6	1	20	814
161760125013	125 x 1 1/4"	32	184	124	196	6	1	20	814
161760125015	125 x 1 1/2"	40	184	124	198	6	1	20	834
161760125020	125 x 2"	50	184	124	208	6	1	20	761
161760140010	140 x 1"	25	201	136	202	6	1	20	948
161760140013	140 x 1 1/4"	32	201	136	212	6	1	20	947
161760140015	140 x 1 1/2"	40	201	136	213	6	1	20	967
161760140020	140 x 2"	50	201	136	223	6	1	20	1001
161760160010	160 x 1"	25	223	145	223	6	1	16	1055
161760160013	160 x 1 1/4"	32	223	145	233	6	1	16	1098
161760160015	160 x 1 1/2"	40	223	145	235	6	1	16	1119
161760160020	160 x 2"	50	223	145	245	6	1	16	1137
161760180010	180 x 1"	25	245	154	243	6	1	16	1310
161760180013	180 x 1 1/4"	32	245	154	253	6	1	16	1335
161760180015	180 x 1 1/2"	40	245	154	255	6	1	16	1247
161760180020	180 x 2"	50	245	154	265	6	1	16	1368

16186 - without reinforcing ring, 16177 - With stainless steel bolts

Plated Nut & Bolt for Saddles

16005*

Tornillo y tuerca de acero niquelado para collarin



Product Code	Bolt Dimensions/mm	Saddles
16005306	6 x 30	20 - 25
16005458	8 x 45	32 - 40 - 50 - 63
16005608	8 x 60	75 - 90 - 110
16005708	8 x 70	125 - 140 - 160 - 180

* Nuts & Bolts also available in stainless steel | * Tornillos y tuercas, a disposición, en acero inoxidable

Mechanical Tapping Valve

18680

Valvula mecanica con salida rotatoria tapper

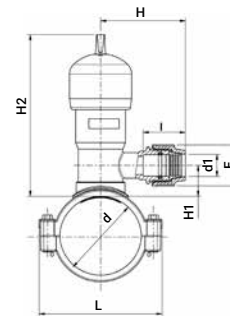

Product Code	Size d x d1	L	L1*	H	H1	H2	E	I	UB	UC	W
186800063032	63 x 32	116	84	135	55	240	64	67	1	8	2090
186800063063	63 x 63	116	84	200	60	240	113	110	1	8	2210
186800075032	75 x 32	122	98	135	60	244	64	67	1	8	1840
186800075063	75 x 63	122	98	200	65	244	113	110	1	8	2230
186800090032	90 x 32	141	105	135	60	244	64	67	1	8	2150
186800090063	90 x 63	141	105	200	65	244	113	110	1	8	2270
186800110032	110 x 32	165	116	135	60	244	64	67	1	8	2270
186800110063	110 x 63	165	116	200	65	244	113	110	1	8	2730
186800125032	125 x 32	184	124	135	60	244	64	67	1	8	2280
186800125063	125 x 63	184	124	200	65	244	113	110	1	8	2390
186800140032	140 x 32	201	136	135	60	244	64	67	1	8	2290
186800140063	140 x 63	201	136	200	65	244	113	110	1	6	2440
186800160032	160 x 32	223	145	135	60	244	64	67	1	6	2490
186800160063	160 x 63	223	145	200	65	244	113	110	1	6	2440
186800180032	180 x 32	245	154	135	60	244	64	67	1	6	2550
186800180063	180 x 63	245	154	200	65	244	113	110	1	4	2550

* L1 - Length along pipe | * L1 - Longitud del collarine



PLASSA SADDLE

PLASSON Mechanical Saddle



"PLASSADDLE" – PLASSON's revolutionary mechanical saddle

PLASSON is proud to introduce its newly designed mechanical saddle, featuring fast, bolt free installation as well as some of our well-established mechanical fitting features:

- Fast and Innovative tightening mechanism
- No bolts
- Non-corrosive, strong and durable plastic parts - no metal components
- Integral seals - no need for thread sealants

PLASSADDLE Threaded

16300

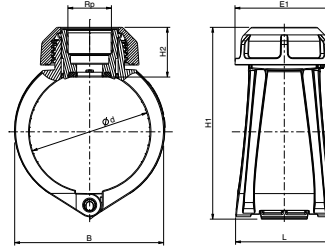

Product Code	Size d x Rp	B	L	E1	H1	H2	UB	UC	W
16300063005*	63 x 1/2"	91	89	102	136	49			
16300063007	63 x 3/4"	91	89	102	136	49			
16300063010	63 x 1"	91	89	102	136	49			
16300063013*	63 x 1 1/4"	91	89	102	146	58			
16300063015	63 x 1 1/2"	91	89	102	136	49			
16300090005*	90 x 1/2"	119	94	102	163	49			
16300090007	90 x 3/4"	119	94	102	163	49			
16300090010	90 x 1"	119	94	102	163	49			
16300090013*	90 x 1 1/4"	119	94	102	173	58			
16300090015	90 x 1 1/2"	119	94	102	163	49			
16300110005*	110 x 1/2"	141	97	102	180	49			
16300110007	110 x 3/4"	141	97	102	180	49			
16300110010	110 x 1"	141	97	102	180	49			
16300110013*	110 x 1 1/4"	141	97	102	190	58			
16300110015*	110 x 1 1/2"	141	97	102	180	49			
16300125005*	125 x 1/2"	157	100	102	198	49			
16300125007	125 x 3/4"	157	100	102	198	49			
16300125010	125 x 1"	157	100	102	198	49			
16300125013*	125 x 1 1/4"	157	100	102	207	58			
16300125015	125 x 1 1/2"	157	100	102	198	49			
16300160005*	160 x 1/2"	197	106	102	235	49			
16300160007	160 x 3/4"	197	106	102	235	49			
16300160010	160 x 1"	197	106	102	235	49			
16300160013*	160 x 1 1/4"	197	106	102	235	58			
16300160015	160 x 1 1/2"	197	106	102	235	49			
16300180005*	180 x 1/2"	220	110	102	255	49			
16300180007	180 x 3/4"	220	110	102	255	49			
16300180010	180 x 1"	220	110	102	255	49			
16300180013*	180 x 1 1/4"	220	110	102	264	58			
16300180015	180 x 1 1/2"	220	110	102	255	49			

* Will be available during 2022

PLASSADDLE Tapper

16310

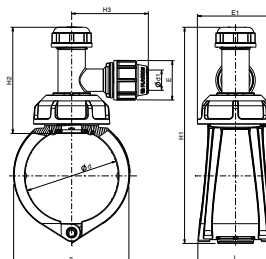

Product Code	Size d x d1	B	L	E	E1	H1	H2	H3	UC	W
163100063025	63 x 25	91	89	54	102	231	144	106	30	642
163100063032	63 x 32	91	89	64	102	231	144	111	30	677
163100090025	90 x 25	119	94	54	102	258	144	106		
163100090032	90 x 32	119	94	64	102	258	144	111	25	748
163100110025	110 x 25	141	97	54	102	273	144	106		
163100110032	110 x 32	141	97	64	102	273	144	111		
163100125025	125 x 25	157	100	54	102	290	144	106	24	820
163100125032	125 x 32	157	100	64	102	290	144	111	16	860
163100160025	160 x 25	198	106	54	102	325	144	106		
163100160032	160 x 32	198	106	64	102	325	144	111		
163100180025	180 x 25	220	110	54	102	350	144	106		
163100180032	180 x 32	220	110	64	102	350	144	111		

PLASSADDLE Tapper Male

1631R

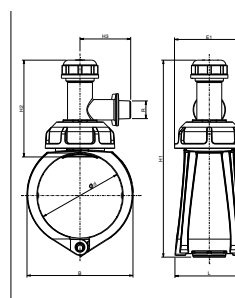

Product Code	Size d x d1	B	L	E1	H1	H2	H3	UC	W
1631R0063010	63 x 1"	91	89	102	231	144	78		
1631R0090010	90 x 1"	119	94	102	258	144	78		
1631R0110010	110 x 1"	141	97	102	273	144	78		
1631R0125010	125 x 1"	157	100	102	290	144	78		
1631R0160010	160 x 1"	198	106	102	325	144	78		
1631R0180010	180 x 1"	220	110	102	350	144	78		

Threaded Socket

050107*

Manguito rosca hembra x hembra

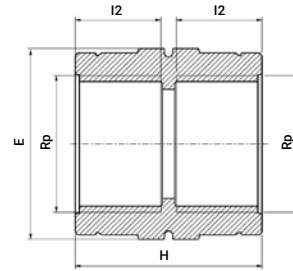

Product Code	Size Rp x Rp	E	H	I2	UB	UC	W
050107005	1/2" x 1/2"	30	39	17	10	1200	15
050107007	3/4" x 3/4"	36	41	19	10	1000	19
050107010	1" x 1"	46	45	21	10	600	31
050107013	1 1/4" x 1 1/4"	60	54	25	10	250	65
050107015	1 1/2" x 1 1/2"	65	54	25	10	250	76
050107020	2" x 2"	75	66	31	5	150	94

* With reinforcing ring - Cat. No. 050117 | * Con anillo de refuerzo - Cat. No. 050117

Threaded Reducing Bushing

050207

Manguito reductor hembra x macho

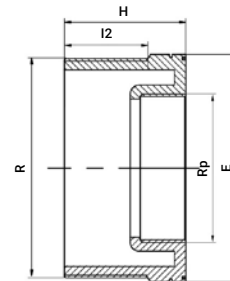

Product Code	Size R x Rp	E	H	I2	UB	UC	W
050207007005	3/4" x 1/2"	27	30	17	10	2000	6
050207010005	1" x 1/2"	36	32	19	10	1000	16
050207010007	1" x 3/4"	36	32	19	10	1000	11
050207013005	1 1/4" x 1/2"	46	37	21	10	700	27
050207013007	1 1/4" x 3/4"	46	37	21	10	700	28
050207013010	1 1/4" x 1"	46	37	21	10	700	21
050207015005	1 1/2" x 1/2"	50	37	21	10	600	34
050207015007	1 1/2" x 3/4"	50	37	21	10	600	32
050207015010	1 1/2" x 1"	50	37	21	10	500	32
050207015013	1 1/2" x 1 1/4"	50	37	21	10	500	20
050207020005	2" x 1/2"	63	41	25	5	350	60
050207020007	2" x 3/4"	63	41	25	5	350	58
050207020010	2" x 1"	63	41	26	5	300	61
050207020013	2" x 1 1/4"	63	41	26	5	320	55
050207020015	2" x 1 1/2"	63	41	26	5	320	44
050207025020	2 1/2" x 2"	80	44	29	5	200	75
050207030010	3" x 1"	90	48	32	2	150	117
050207030013	3" x 1 1/4"	90	48	32	2	150	119
050207030015	3" x 1 1/2"	90	48	32	2	150	118
050207030020	3" x 2"	90	48	32	2	100	103
050207030025	3" x 2 1/2"	90	48	32	2	150	75
050207040020	4" x 2"	120	56	41	2	80	238
050207040030	4" x 3"	120	56	41	2	80	222

90° Threaded Tee

050407*

Te de 90° rosca hembra

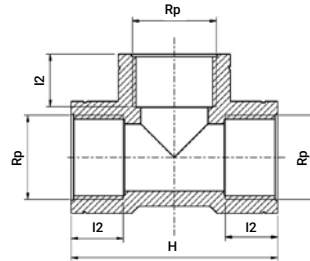

Product Code	Size Rp	H	I2	UB	UC	W
050407005	1/2"	64	18	10	700	28
050407007	3/4"	68	19	10	500	39
050407010	1"	81	21	10	260	61
050407013	1 1/4"	96	25	5	140	114
050407015	1 1/2"	108	25	5	90	157
050407020	2"	130	30	5	60	205

* With reinforcing ring - Cat. No. 050417 | * Con anillo de refuerzo - Cat. No. 050417

90° Threaded Elbow

050507*

Codo de 90° rosca hembra

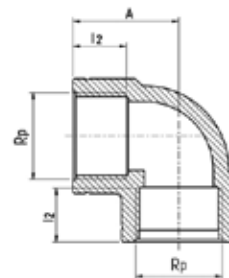

Product Code	Size Rp x Rp	A	I2	UB	UC	W
050507005	1/2" x 1/2"	32	17	10	1000	22
050507007	3/4" x 3/4"	35	18	10	700	30
050507010	1" x 1"	41	21	10	400	45
050507013	1 1/4" x 1 1/4"	48	25	10	200	87
050507015	1 1/2" x 1 1/2"	54	25	5	150	116
050507020	2" x 2"	65	30	5	80	157

* With reinforcing ring - Cat. No. 050517 | * Con anillo de refuerzo - Cat. No. 050517

90° Threaded Elbow Male x Female

051507

Codo roscado-macho x hembra

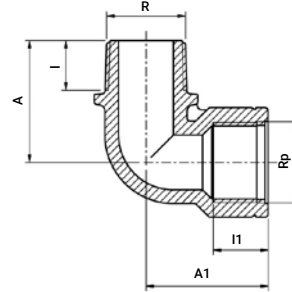

Product Code	Size R x Rp	A	A1	I	I1	UB	UC	W
051507005	1/2" x 1/2"	36	36	16	17	10	1000	17
051507007	3/4" x 3/4"	40	40	17	18	10	700	25
051507010	1" x 1"	45	47	19	21	10	400	40

Threaded Reducing Nipple

050605

Machón doble reductor

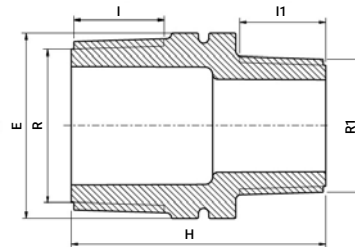

Product Code	Size R x R1	E	H	I	I1	UB	UC	W
050605007005	3/4" x 1/2"	27	47	17	16	10	1500	10
050605010005	1" x 1/2"	36	49	19	16	10	800	17
050605010007	1" x 3/4"	36	50	19	17	10	800	18
050605013005	1 1/4" x 1/2"	46	53	21	16	10	500	28
050605013007	1 1/4" x 3/4"	46	54	21	17	10	500	29
050605013010	1 1/4" x 1"	46	56	21	19	10	500	31
050605015005	1 1/2" x 1/2"	50	54	21	16	5	500	34
050605015007	1 1/2" x 3/4"	50	55	21	17	5	500	34
050605015010	1 1/2" x 1"	50	57	21	19	5	400	36
050605015013	1 1/2" x 1 1/4"	50	59	21	21	5	400	39
050605020005	2" x 1/2"	63	58	25	16	5	280	51
050605020007	2" x 3/4"	63	59	25	17	5	260	52
050605020010	2" x 1"	63	61	25	19	5	260	53
050605020013	2" x 1 1/4"	63	63	25	21	5	240	57
050605020015	2" x 1 1/2"	63	63	25	21	5	240	58

Threaded Nipple

050607

Machón doble

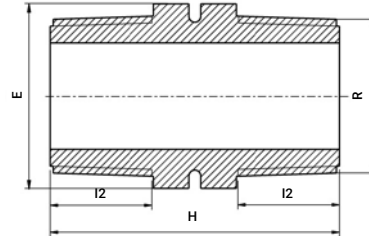

Product Code	Size R x R	E	H	I2	UB	UC	W
050607005	1/2" x 1/2"	22	47	17	10	1800	8
050607007	3/4" x 3/4"	27	49	18	10	1500	11
050607010	1" x 1"	36	55	20	10	800	23
050607013	1 1/4" x 1 1/4"	46	60	22	10	400	35
050607015	1 1/2" x 1 1/2"	50	61	22	5	300	48
050607020	2" x 2"	65	71	26	5	180	78

Threaded Cap

050707

Machón doble

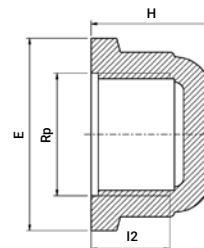

Product Code	Size Rp	E	H	I2	UB	UC	W
050707005	1/2"	37	25	15	10	1600	13
050707007	3/4"	42	26	16	10	1500	14
050707010	1"	50	32	19	10	800	27
050707013	1 1/4"	59	34	22	10	500	39
050707015	1 1/2"	65	34	21	10	450	43
050707020	2"	80	39	25	5	250	78

Threaded Reducing Socket

051107

Manguito reductor rosca hembra - hembra

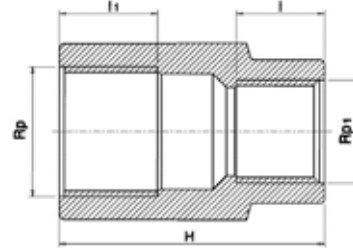

Product Code	Size Rp x Rp1	E	H	I	I1	UB	UC	W
051107007005	3/4" x 1/2"	36	50	20	19	10	800	24

Threaded Riser

051607

Espiga roscada

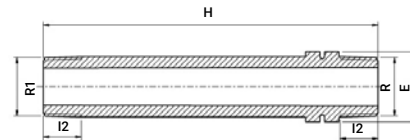

Product Code	Size R x R1	E	H	I2	UB	UC	W
051607005	1/2" x 1/2"	22	150	17	10	600	30
051607007005	3/4" x 1/2"	27	113	18	10	500	26
051607007	3/4" x 3/4"	27	150	18	10	400	43
051607010	1" x 1"	36	150	19	5	250	65
051607013	1 1/4" x 1 1/4"	46	150	21	5	150	93
051607015013	1 1/2" x 1 1/4"	50	150	21	5	140	120
051607015	1 1/2" x 1 1/2"	50	150	21	5	140	120

Threaded Plug

051707

Tapón rosca macho

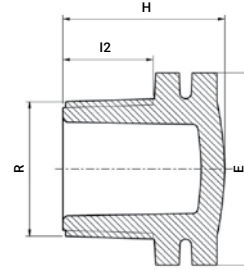

Product Code	Size R	E	H	I2	UB	UC	W
051707003	3/8"	22	24	13	10	4500	4
051707005	1/2"	27	29	16	10	2000	8
051707007	3/4"	32	31	17	10	1500	12
051707010	1"	36	34	19	10	1000	16
051707013	1 1/4"	46	38	21	10	700	26
051707015	1 1/2"	55	39	21	10	500	38
051707020	2"	65	45	25	10	300	60

Ball Valve

03703

Válvula esférica



Product Code	Size DN x Rc	E	H	I	B	A1	A2	UC	W
0370300005	15 x 1/2"	53	97	17.5	36	27	54	72	180
0370300007	20 x 3/4"	53	97	17.5	36	27	54	72	175
0370300010	25 x 1"	64	116	20.5	46	33	64	72	313
0370300013	32 x 1 1/4"	73	118	20	55	36	70	48	393
0370300015**	40 x 1 1/2"	91	144	24	65	41	87	30	712
0370300020**	50 x 2"	106	162	29	75	53	95	24	918

* 037030F - with drain port | * 037030F – con sistema de purga

** Long handle

New ball valves can be found in page 227

PA Ball Valve Female x Male

NEW!

0370302

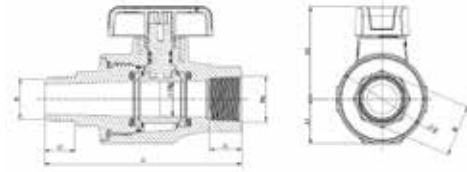

Product Code	Size RcxR	Rp	DN	A1	A2	H	I1	I2	B	E	UC	W
03703020S00005	1/2" x 1/2"	1/8"	20	27	54	114	18	17	27	53	72	190
03703020S00007	3/4" x 3/4"	1/8"	20	27	54	117	19	18	30	53	72	180
03703020S00010	1" x 1"	1/8"	25	33	64	133	22	21	41	64	72	320

* 03703020SF - with drain port | * 03703020SF – con sistema de purga

Threaded Stoptap (Seal NBR)

03405

Válvula de línea rosca hembra (juntas NBR)

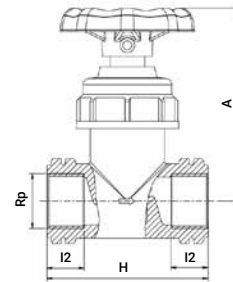

Product Code	Size Rp x Rp	H	I2	A	UB	UC	W
03405077	3/4" x 3/4"	78	18	95	5	140	115
03405110	1" x 1"	82	20	95	5	120	129

Compression Stoptap (Seal NBR)

03407

Válvula de línea compresión (juntas NBR)

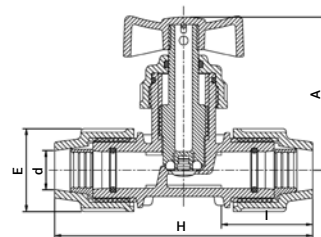

Product Code	Size d	E	H	I	A	UB	UC	W
03407020	20 x 20	48	147	47	87	5	100	168
03407025	25 x 25	54	154	49	87	5	80	190
03407032	32 x 32	64	174	57	87	5	60	260

Angle Seat Valve (Seal NBR) Threaded x Compression 03048/03948

Válvula de asiento angular - compresión - rosca macho - juntas NBR

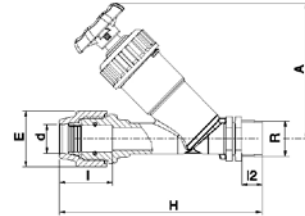

Product Code	Size d x R	E	H	I	I2	A	UB	UC	W
03048200	20 x 1/2"	48	174	57	16	113	—	100	176
03048250	25 x 3/4"	54	187	60	18	121	—	80	238
03048320	32 x 1"	64	212	70	20	140	—	50	360
03948400	40 x 1 1/4"	82	299	84	22	180	—	26	605
03948505	50 x 1 1/2"	96	259	93	22	207	—	17	924
03948630	63 x 2"	113	340	110	26	246	—	10	1518

Angle Seat Valve (Seal NBR) Threaded Inlet & Outlet 03047*

03047*

Válvula de asiento angular, (sello NBR) roscas macho

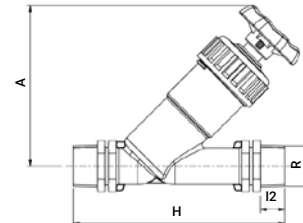

Product Code	Size R x R	H	I2	A	UB	UC	W
03047055	1/2" x 1/2"	135	16	113	5	120	142
03047077	3/4" x 3/4"	151	18	121	5	100	186
03047110	1" x 1"	170	20	140	—	70	291
03047188	1 1/4" x 1 1/4"	225	22	207	—	40	474
03047155	1 1/2" x 1 1/2"	200	22	180	—	24	733
03047220	2" x 2"	254	26	246	—	15	1191

* Available with NPT thread | * Disponible con rosca NPT

Angle Seat Valve (Seal FPM) Threaded Inlet & Outlet

03049*

Válvula de asiento angular, (sello FPM) roscas macho

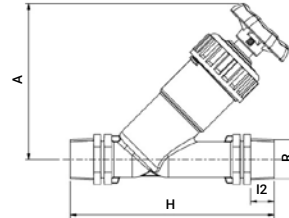

Product Code	Size R x R	H	I2	A	UB	UC	W
03049055	1/2" x 1/2"	135	16	113	5	120	136
03049077	3/4" x 3/4"	151	18	121	5	100	191
03049110	1" x 1"	170	20	140	—	70	295
03049188	1 1/4" x 1 1/4"	200	22	180	—	40	474
03049155	1 1/2" x 1 1/2"	225	22	207	—	24	733
03049220	2" x 2"	254	26	246	—	15	1207

* Available with NPT thread | * Disponible con rosca NPT

Angle Seat Valve (Seal NBR) Compression Inlet & Outlet

03046

Válvula de asiento angular, (sello NBR) compresión

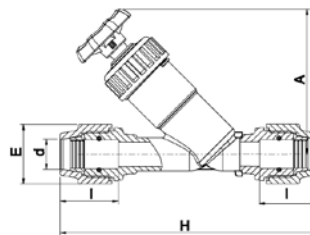

Product Code	Size d x d	E	H	I	A	UB	UC	W
03046320	32 x 32	64	254	70	140	—	40	438

Check Valve (Seal EPDM) Threaded Inlet & Outlet

03067/03068*

Válvula antirretorno, (sello EPDM) roscas macho

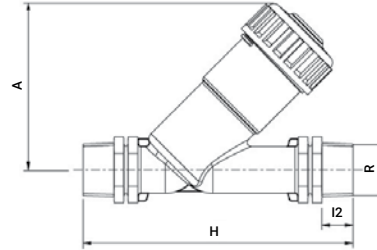

Product Code	Size R	H	I2	A	UB	UC	W
03067077	3/4" x 3/4"	151	18	96	5	140	141
03067110	1" x 1"	170	20	106	5	100	210
03067188	1 1/4" x 1 1/4"	200	22	134	—	55	382
03067155	1 1/2" x 1 1/2"	225	22	155	—	35	586
03067220	2" x 2"	254	26	182	—	20	975

* Available with NPT thread | * Disponible con rosca NPT

Fixed Ratio Pressure Reducing Valve

03801

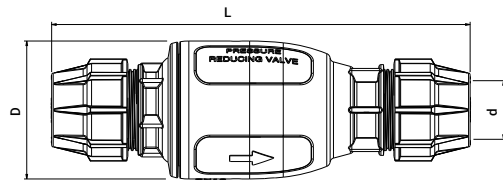

Product Code	pressure reducing ratio	Size d	D	L	UB	UC	W
03801200630A	2:1	63*	150	450	—	6	3035
03801300630A	3:1	63*	150	450	—	6	3035
03801201100A	2:1	110	245	770	1	1	15500
03801301100A	3:1	110	245	770	1	1	15500

* For 2" male R use threaded adaptor 0725060630200A

Universal Pressure Regulator UPR 550

0220

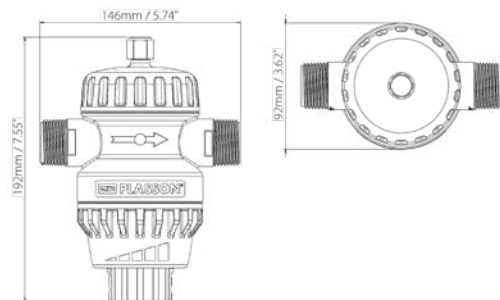

Product Code	Inlet/Outlet	Inlet Pressure	Outlet Pressure	UB	UC	W
02206500	1" R	0.5-16 bar	0.5-4.0 bar	—	30	700
02205950	1" NPT	0.5-16 bar	0.5-4.0 bar	—	30	700

Quick Coupling Valve (Seal NBR)

03039

Válvula de acople rápido (juntas NBR)

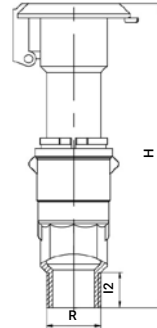

Product Code	Size R	H	I2	UB	UC	W
03039037	3/4"	152	17	5	130	146
03039030	1"	154	18	5	130	148

Key for Quick Coupling Valve 3039

03139

Conexión de acople rápido

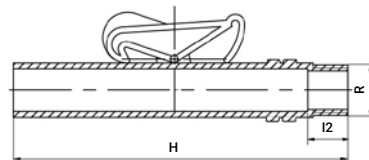

Product Code	Size R	H	I2	UB	UC	W
03139020	3/4"	173	18	5	250	66

Check Valve Insert

03226/03227

Válvula de antirretorno

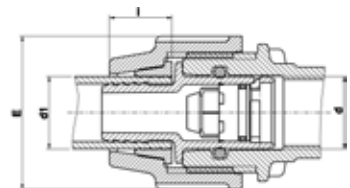
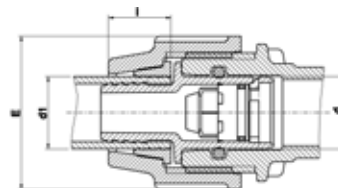

Product Code	Size d x d1	E	I	UB	UC	W
03226025	25 x 25	63	22	-	800	15

Male Rc thread to G threaded Free Nut

03589

Tubo y tuerca BSPT

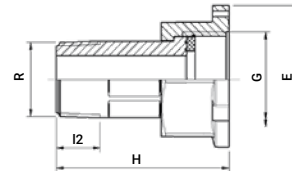

Product Code	Size G x R	E	H	I2	UB	UC	W
0358906005	3/4" x 1/2"	40	56	16	2	150	60
0358906007	1" x 3/4"	48	61	16	2	150	92

Water Meter Seat

03510T

Soporte para control de flujo de agua

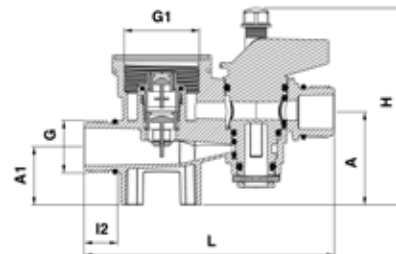

Product Code	Size G x G1 x G	L	I2	A	A1	H	UC	W
03510TT010010	1"x1½"x1"	160	21	59	37	130	60	270

Water Meter Manifold

035100

Soporte para control de flujo de agua

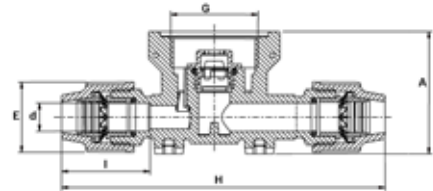
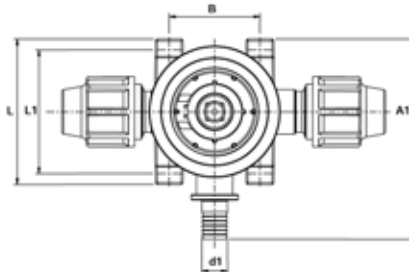

Product Code	Size d x G1 x d	H	I	E	A	A1	L	L1	B	d1	UC	W
03510000	15 x 1 1/2" x 15	178	49	39	67	110	80	68	50	14	80	100

PP Ball Valve

036010

PP Válvula de esfera

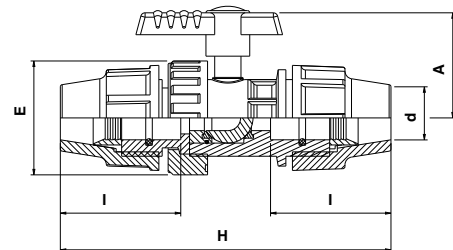

Product Code	Size d	E	H	I	A	UB	UC	W
036010020	20	52	151	55	48	—	—	150
036010025	25	60	160	55	60	—	—	200
036010032	32	78	186	62	70	—	—	350

PP Ball Valve Male Adaptor

036020

PP Válvula de esfera rosca macho

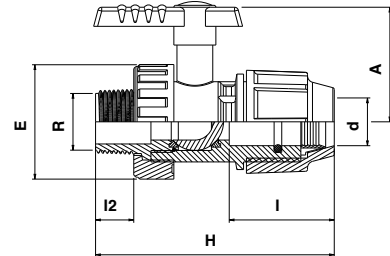

Product Code	Size d x R	E	H	I	I2	A	UB	UC	W
036020020005	20 x 1/2"	52	113	55	17	48	—	—	120
036020025007	25 x 3/4"	60	123	55	18	60	—	—	160
036020025010	25 x 1"	60	125	62	20	60	—	—	167
036020032010	32 x 1"	78	144	62	20	70	—	—	280

PP Ball Valve Female Adaptor

036030

PP Válvula de esfera rosca hembra

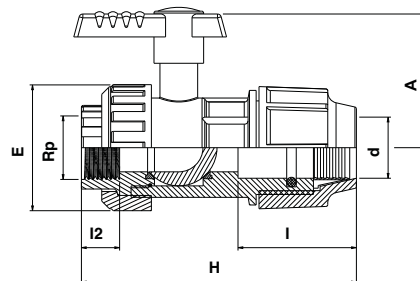

Product Code	Size d x Rp	E	H	I	I2	A	UB	UC	W
036030020005	20 x 1/2"	52	113	55	17	48	—	—	120
036030025007	25 x 3/4"	60	123	55	18	60	—	—	160
036030032010	32 x 1"	78	144	62	20	70	—	—	280
036030032013	32 x 1 1/4"	78	144	62	23	70	—	—	280

Quarter Turn Valve Male Threaded x Compression

03010

Rosca Macho/ Compresión

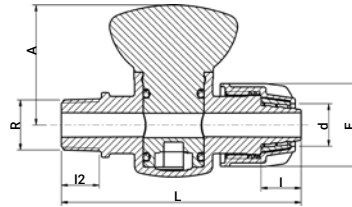

Product Code	Size d x R	L	A	E	I	I1	UB	UC	W
03010516	16 x 1/2"	98	49	34	17	15	10	450	68
03010716	16 x 3/4"	99	49	34	17	17	10	400	72

Quarter Turn Valve Male Threaded x Female Threaded

03012

Rosca Macho-/Rosca Hembra

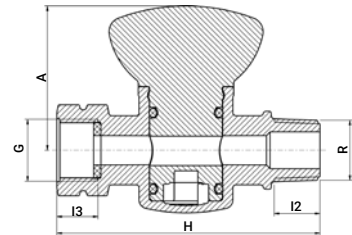

Product Code	Size G x R	H	A	I1	I2	UB	UC	W
03012055	1/2" x 1/2"	89	49	15	14	10	450	46
03012077	3/4" x 3/4"	97	49	17	18	10	400	73

Quarter Turn Valve Compression x Compression

03017

Compresión

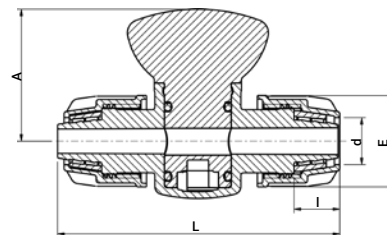

Product Code	Size d x d	L	A	E	I	UB	UC	W
03017016	16 x 16	105	49	34	17	10	350	70

Technical Specifications and Installation Instructions

Technical Specifications

Materials

Compression Fittings

Body: Polypropylene, high-grade copolymer.
 Nut: Polypropylene, high-grade copolymer.
 Split Ring: Acetal POM (CPVC also available).
 Liner: Acetal (POM).
 Seal: Nitrile rubber NBR (EPDM, FPM also available).
 Reinforcing ring: Stainless steel on all female offtakes from 1 1/4" up to 4".
 Bolts (Series 17): Plated steel.
 Nuts (Series 17): Stainless steel.

Valves

Body: Polypropylene, high-grade copolymer.
 O-Ring: See inside.
 Spring: (items 03067, 03039), Stainless steel.

Saddles

Body: Polypropylene, high-grade copolymer.
 Bolts and Nuts: Plated steel.
 (Stainless steel bolts and nuts also available)
 Reinforcing Rings: Stainless steel.
 Seal: Nitrile rubber (NBR).

Tappers + Compression Saddles Body: Polypropylene, high-grade copolymer.
 Split Rings: Acetal (POM, CPVC also available).
 Nuts: Polypropylene, high-grade copolymer.
 Bolts and Nuts: Stainless Steel.
 Seal: EPDM.

Threaded Fittings

Body: Polypropylene, high-grade copolymer.
 Reinforcing Ring: Stainless Steel.

Operating Temperatures

The fittings and valves are not to be used with hot water, although they withstand the same temperature as the polyethylene pipe itself. The fittings and valves will withstand sub-zero temperatures.

Chemical Resistance

PLASSON Fittings are supplied, as standard, with polyacetal split rings and NBR O-rings which are suitable for water. For aggressive chemical applications CPVC split rings and EPDM or FPM O-rings can be supplied to produce a better chemical resistance.

Operating Pressures and Quality Certificates

PLASSON Fittings are tested and approved according to ISO 17885 for water (replaced ISO 14236) and AS/NZ 4129. For detailed pressure classification see page 84.

Threads

Threads marked "R", "Rp" and "Rc" are according to ISO 7-1. Threads marked "G" are according to ISO 228.

Flanges

Flange dimensions in accordance with: ISO 7005-1 (TABLE 11), BS 4504: 1989 (TABLE 11), DIN 2501 (PN 16 TABLE), AS/NZS 4331. Metal backing rings to be used with all flanges.

Legend	
UB	Units per bag
UC	Units per carton
W	Weight in grams

Note

Before installation ensure that the end of the pipe to be inserted into the fitting is free of scratches and other imperfections and that both the pipe and the fitting itself are clean of sand, mud, stones etc.

Do not over tighten nut when closing. Never use wrenches or spanners with handle lengths longer than 46 cm - excessive torque during tightening can spread nut cone and result in pull outs.

If fittings are reused, ensure split ring is sharp and bites into pipe to avoid pull outs. Alternatively replace split ring.

Pull out resistance of Series 7 fittings combined with the UPVC/PP grip ring has been approved by pressure testing UPVC/PP pipe assemblies at 25 bar operating pressure for at least 1 hour.

Note: We strongly recommend the use of PTFE tape in threaded connections.

Especificaciones Técnicas

Materiales

Accesorios de compresión

Cuerpo: Polipropileno, block copolímero de alta calidad.
 Racor: Polipropileno, block copolímero de alta calidad.
 Casquillo de apriete: Acetal (POM).
 Disponibles también en PVC-C.
 Refuerzo interno de tubos: Acetal (POM).
 Junta tórica: Nitrilo (NBR).
 disponibles también en EPDM y FPM
 Anillo de refuerzo: Acero inoxidable en todas las
 tomas roscadas hembra de 1 1/4" a 4".
 Tornillos (Series 17): Acero niquelado.
 Tuercas: Acero inoxidable.

Válvulas

Cuerpo: Polipropileno, block copolímero de alta calidad.
 Junta tórica: Ver catálogo.
 Resorte: (03067, 03039), Acero inoxidable.

Collarines

Cuerpo: Polipropileno, block copolímero de alta calidad.
 Tornillos y tuercas: Acero niquelado.
 (También se dispone de tornillos y tuercas de acero
 inoxidable)
 Anillo de refuerzo: Acero inoxidable.
 Juntas: NBR.

Tapper y Collarín de compresión

Cuerpo: Polipropileno, block copolímero de alta calidad.
 Casquillo de apriete: Acetal (POM).
 disponibles también en PVC -C
 Racor: Polipropileno, block copolímero de alta calidad.
 Tornillos y tuercas: Acero inoxidable.
 Juntas: EPDM.

Accesorios roscados

Cuerpo: Polipropileno, block copolímero de alta calidad.
 Anillo de refuerzo: Acero inoxidable.

Temperaturas de Trabajo

Los accesorios y las válvulas no son recomendados para
 usar con agua caliente, aunque soportan las mismas
 temperaturas que las propias tuberías de polietileno.
 Sin embargo pueden resistir temperaturas inferiores a los
 cero grados centígrados.

Resistencia a las Sustancias Químicas

Los accesorios PLASSON están provistos, como estándar,
 con Casquillos de Apriete de resina acetálica y Juntas tóricas
 de NBR, recomendados para usar con agua potable. Para las
 aplicaciones de productos químicos agresivos se ofrecen
 Casquillos de Apriete de CPVC y Juntas tóricas de EPDM
 o FPM, que resisten mejor a las sustancias químicas.

Presiones de Funcionamiento y Certificados de Calidad

Todos los accesorios de PLASSON se someten a pruebas de
 aprobación, de conformidad con las normativas ISO 17885
 - Agua (Reemplaza a la ISO 14236) y AS/NZ 4129. Para ver
 una clasificación detallada de las presiones, consulte la
 página 85.

Roscas

Roscas marcadas "R", "Rp" y "Rc" de conformidad con la
 normativa ISO 7-1.
 Roscas "G" de conformidad con la normativa ISO 228.

Bridas

Las dimensiones de las bridas responden a las normas
 ISO 7005-1 (TABLE 11),
 BS 4504: 1989 (TABLE 11),
 DIN 2501 (PN 16 TABLE), AS/NZS 4331
 Con todas las bridas debe ser utilizado como refuerzo una
 brida de metal.

Legend	
UB	Unidades por bolsa
UC	Unidades por carton
W	Peso en gramos

Nota

Antes de la instalación asegure que:
 El extremo del tubo introducido no tenga imperfecciones o
 rayaduras Tanto el tubo como el accesorio no tenga sobre
 los mismos arena, barro o piedras, etc. No cierre el racor con
 extremada fuerza, nunca use llaves con manijas más largas
 de 46 cm. Un excesivo momento de torsión durante el cierre
 puede dañar el cono del racor y como resultado del mismo
 no permitir su propio funcionamiento Si los accesorios son
 usados nuevamente después de su desarmado, constate que
 los dientes del casquillo de apriete permanecen afilados y se
 hincan en el tubo impidiendo el escape del tubo. Si no es así,
 cambie el casquillo de apriete.

La resistencia a tracción de accesorios de Serie 7 que
 combinan el uso de casquillo de apriete para tubos de UPVC
 / PP ha sido aprobada por medio de pruebas de presión para
 tubos UPVC / PP con una presión de operación de 25 bar
 durante al menos 1 hora

Nota: Recomendamos utilizar cinta de PTFE para sellar todas
 las conexiones roscadas.

Technical Specifications

Pressure Rating of PLASSON Mechanical Fittings and Valves

Product Code	Body Type	Pressure Rating	Stainless Steel Reinforcement Ring	From Pipe Diameter	To Pipe Diameter	From Thread	To Thread	From Outlet Size	To Outlet Size
line 7/87 compression fittings									
Starts with 07 and 87	All Fitting Types	16.0							
Exceptions:									
Starts with 07	All 160 mm Fittings	10.0							
Starts with 07 and 87	All Fittings with 3 inch Female Thread	10.0							
Starts with 07 and 87	All Fittings with 4 inch Female Thread	6.0							
0701070/ 0705070	Plass 4 (Universal)	10.0		50	50			35	50
0704P	90° Slip Tee	12.5		40	63				
07120	Plug Adaptor	12.5		20	63				
07220	Compression Flange Adaptor	12.5		125	125				
07250	Threaded Adaptor	12.5		75	75	1 1/2	3		
07640	45° Tee	8.0		63	63				
87640	45° Tee	8.0		75	110				
87930	Reducing Set 110X63	10.0							
Valves									
03046/03047/03048/03049	Angle Seat Valve	8.0							
03405	Threaded Stoptap	10.0				3/4	1		
03407	Compression Stoptap	16.0		20	32				
03039	Quick Coupling Valve	10.0				3/4	1		
03067	Check Valve	8.0							
03703	PA ball valve	16.0							
0360	PP ball valve	16.0							
line 5 threaded fittings									
Starts with 05	All fittings	16.0							
Exceptions									
0501/0504/0505	socket /elbow /Tee without reinforcement ring	10.0	NO			1 1/4	2		
050207/ 050707	Threaded Reducing Bushing/Threaded Cap	10.0				1 1/4	2		
Saddles									
160760	Saddle Single Outlet	12.5	YES	20	63	1/2	1 1/2		
160760	Saddle Single Outlet	12.5	YES	75	180	1/2	3/4		
160760	Saddle Single Outlet	10.0	YES	75	180	1	2		
160761	Saddle Single Outlet	16.0	YES	40	180	1	1		
160860	Saddle Single Outlet	6.0	NO	20	180	1 1/4	2		
160860	Saddle Single Outlet	10.0	NO	20	180	1/2	1		
161760	Saddle Double Outlet	12.5	YES	20	63	1/2	1 1/2		
161760	Saddle Double Outlet	12.5	YES	75	180	1/2	3/4		
161760	Saddle Double Outlet	10.0	YES	75	180	1	2		
161860	Saddle Double Outlet	6.0	NO	20	180	1 1/4	2		
161860	Saddle Double Outlet	10.0	NO	20	180	1/2	1		
16279	Saddle Single Outlet	16.0	YES	63	180	1 1/2	1 1/2		
16310,16300,1631R	PLASSADDLE	16.0							
Silver line compression fittings									
starts with 14	All fittings	10.0							
Series 1 compression fittings									
starts with 10	All fittings	16.0							

Especificaciones Técnicas

Presiones Nominales (PN) de Accesorios y Válvulas Mecánicas / Compresión de PLASSON

Código de producto	Tipo	Presión Nominal	Anillo de Refuerzo de Acero Inoxidable	From Pipe Diameter	To Pipe Diameter	From Thread	To Thread	From Outlet Size	To Outlet Size
Accesorios de Compresión Serie 7 / 87									
Starts with 07 and 87	All Fitting Types	16.0							
Excepciones:									
Starts with 07	All 160 mm Fittings	10.0							
Starts with 07 and 87	All Fittings with 3 inch Female Thread	10.0							
Starts with 07 and 87	All Fittings with 4 inch Female Thread	6.0							
0701070/ 0705070	Plass 4 (Universal)	10.0		50	50			35	50
0704P	90° Slip Tee	12.5		40	63				
07120	Plug Adaptor	12.5		20	63				
07220	Compression Flange Adaptor	12.5		125	125				
07250	Threaded Adaptor	12.5		75	75	1 1/2	3		
07640	45° Tee	8.0		63	110				
87930	Reducing Set 110X63	10.0							
Válvulas									
03046/03047/03048/03049	Angle Seat Valve	8.0							
03405	Threaded Stoptap	10.0				3/4	1		
03407	Compression Stoptap	16.0		20	32				
03039	Quick Coupling Valve	10.0				3/4	1		
03067	Check Valve	8.0							
03703	PA ball valve	16.0							
0360	PP ball valve	16.0							
Accesorios Roscados Línea 5									
Starts with 05	All fittings	16.0							
Excepciones									
0501/0504/0505	socket /elbow /Tee without reinforcement ring	10.0	NO			1 1/4	2		
050207/ 050707	Threaded Reducing Bushing/Threaded Cap	10.0				1 1/4	2		
Collarines/ Arranques/ Tomas simples									
160760	Saddle Single Outlet	12.5	YES	20	63	1/2	1 1/2		
160760	Saddle Single Outlet	12.5	YES	75	180	1/2	3/4		
160760	Saddle Single Outlet	10.0	YES	75	180	1	2		
160761	Saddle Single Outlet	16.0	YES	40	180	1	1		
160860	Saddle Single Outlet	6.0	NO	20	180	1 1/4	2		
160860	Saddle Single Outlet	10.0	NO	20	180	1/2	1		
161760	Saddle Double Outlet	12.5	YES	20	63	1/2	1 1/2		
161760	Saddle Double Outlet	12.5	YES	75	180	1/2	3/4		
161760	Saddle Double Outlet	10.0	YES	75	180	1	2		
161860	Saddle Double Outlet	6.0	NO	20	180	1 1/4	2		
161860	Saddle Double Outlet	10.0	NO	20	180	1/2	1		
16279	Saddle Single Outlet	16.0	YES	63	180	1 1/2	1 1/2		
16540	All Tappers - for PVC & PE Pipes	16.0							
Línea Silver – Accesorios de Compresión									
starts with 14	All fittings	10.0							
Serie 1 – Accesorios de Compresión									
starts with 10	All fittings	16.0							

Installation Instructions for Compression Fittings

ASSEMBLY AS SIMPLE AS ABC...

For Fittings 16mm - 63mm / Para accesorios de 16mm - 63mm

Cut the pipe square, remove burrs • Undo the nut to the last thread. Leave the nut on the fitting while inserting the pipe.

Corte el tubo al tamaño requerido y realice el biselado al final del tubo • Retire el racor hasta su última rosca dejándolo en el accesorio durante el próximo paso.



Twist the pipe into the fitting* through the split ring and rubber seal to the pipe stop • Tighten the nut firmly. Use a PLASSON wrench (or similar tool) for final tightening of sizes 40 and above.

Introduzca el tubo con un movimiento circular dentro del accesorio pasando el casquillo de apriete y el sello hasta llegar al tope interno del accesorio • Gire firmemente el racor en dirección del cuerpo del accesorio, utilizando la llave PLASSON (o similar) en los tamaños 40mm y mayores.



The nut should be closed tightly, however there is no need for the nut to actually meet the body shoulder.

Cierre el racor firmemente, aunque no es necesario cerrarlo hasta el tope.



* Lubrication and chamfering of the pipe end will ease insertion of the pipe (use silicone lubricant).

* A fin de facilitar la introducción es conveniente lubricar y biselar el tubo (con un lubricante que conforma las normas de aprobación de calidad del agua).

Installation Instructions for Compression Fittings

ASSEMBLY AS SIMPLE AS ABC...

For Fittings 75mm - 110mm / Para accesorios de 75mm - 110mm

Cut the pipe square, remove burrs

Undo the nut until 3-4 threads are visible.

Abra el racor hasta que se vean 3-4 roscas.
Corte el tubo en escuadra y quite las virutas del corte



Insert the pipe into the fitting until the stop.

Introduzca el tubo hasta que éste llegue a tocar perpendicularmente el cuerpo del accesorio.



Tighten the nut firmly with a PLASSON wrench.

Cierre firmemente el racor con la llave PLASSON.



Installation Instructions for Pipe Adaptors Conversion Sets

Universal Pipe Adaptors: Copper, Galvanised and Imperial U-PVC (Without Pullout Resistance)

Juegos de conversión de tubería: galvanizada, de cobre o de UPVC medidas imperiales (sin resistencia a la tracción)



Prepare pipe by ensuring that the end is free from grease and roughen the outer surface with wire wool or similar. Cut pipe end square. Remove nut from end of fitting and discard white split ring.



Push adaptor into fitting to the stop. Push and twist the pipe until it meets the internal stop.



Screw nut tightly towards the body of the fitting. Final tightening with a wrench is essential. The installation should be firmly anchored against end loading.

Se prepara el tubo asegurándose que el final del tubo no tenga grasa, y se lija el exterior con lana de alambre. Se hace un corte perpendicular al final del tubo. Se lleva el racor al final del accesorio y se quita el casquillo de apriete blanco.

Se empuja el adaptador en el tubo hasta el tope se empuja y se enrosca el tubo hasta que llegue al tope interior del accesorio.

Se aprieta firmemente el racor hacia el interior del accesorio. Es imprescindible que se apriete con una llave. Después, anclar firmemente la instalación.

Installation Instructions for Pipe Adaptors Conversion Sets

Adaptor Set for Copper (With Pullout Resistance) Juego de adaptadores para cobre (con resistencia a traccion)



Cut pipe square. Remove burrs. Ensure pipe is free of scratches, dents and other imperfections. Remove nut from fitting and discard white split ring. Make a mark on the pipe to the depth of the rubber insert. Assemble nut, brown ring and stainless steel ring onto pipe in that order. Ensure the brown ring tapers towards the nut and the stainless steel ring towards the fitting body.



Push insert into fitting body fully up to the flange.



Push pipe end into body of fitting. Ensure to insert at least to the mark you have made. Push both the rings up to the insert flange and engage nut. Use a PLASSON wrench for final tightening.

Corte el tubo a escuadra, limpie los restos del corte. Asegure que el tubo no este rayado, dentado, con virutas o con otras imperfecciones. Se lleva el racor hasta el final del accesorio y se quita el casquillo de apriete blanco. Se hace una marca en la superficie del tubo que es la profundidad del adaptador de goma. Se colocan el racor, el anillo marrón y el anillo de acero en el tubo, en este orden. Se comprueba que el anillo marrón se remata hacia la tuerca y el anillo de acero hacia el interior del accesorio.

Introducir el adaptador en el interior del accesorio hasta el final.

Introducir el tubo en el interior del accesorio. Comprobar que se introduce por lo menos hasta la marca hecha previamente. Se empujan ambos anillos hasta el adaptador de goma y se cierra firmemente el racor. Para apretar firmemente se debe utilizar la llave PLASSON.

Installation Instructions for Pipe Adaptors Conversion Sets

Lead Pipe Adaptor Adaptadores para tuberías de plomo



Remove nut from fitting and discard white split ring. Mount nut on pipe followed by brown split ring and seal ring.



Push both components onto the pipe until the seal ring is 20mm from the end of pipe and touching the split ring.



Enter pipe into fitting body and tighten firmly with a wrench. (It is important that the pipe is not pushed fully to the stop in the fitting).

Note for lead pipe adaptors: This product seals on the outside diameter of the pipe and it is therefore important that the lead pipe is in good condition on the external part of the pipe where the seal is made. Variation in the lead piping sometimes results in oversized pipes. In these circumstances it may be preferable to use the white split ring provided with the fitting.

Se lleva el racor al final del accesorio y se quita el casquillo de apriete blanco. Se monta el racor al tubo seguido por el casquillo marrón y el anillo de goma.

Se empujan los dos componentes hasta que el anillo de goma esté a 20mm del final del tubo, y tocando el casquillo de apriete marrón.

Se introduce el tubo en el interior del accesorio y se aprieta firmemente con una llave (es importante que no se empuje el racor completamente hasta el final del accesorio).

Nota: El sellado con este producto se realiza con el diámetro exterior del tubo, y por lo tanto es importante que el exterior de la tubería de plomo esté en buen estado. Los variaciones en la tubería de plomo resultan a veces demasiado grandes. En estas circunstancias es preferible usar el casquillo de apriete que está previsto con el accesorio.

Installation Instructions for PLASS4 (Universal) Fittings



Instrucciones para la instalacion de accesorios plass4

Cut the pipe square and remove all burrs and sharp edges.

Select correct fitting according to the external diameter of the pipe.

Slide the PLASS4 fitting (universal side) onto the pipe, until it reaches the internal fins and a slight resistance is felt.

Do not force the pipe end past the fins.

Holding the PLASS4 body with a wrench, tighten the PLASS4 universal nut firmly with a wrench (size 35-50 tighten nut very firmly to approx. 90 NM)

Assemble the metric PE joint as per the standard fitting instructions.

Note: If reusing the fitting, ensure the metal teeth are located in the grip ring and pipe end does not pass the location fins in the body.

Corte el tubo a escuadra y elimine todas las virutas y cantos vivos.

Elija el accesorio apropiado de acuerdo con el diámetro del tubo.

Introduzca el accesorio PLASS4 (del lado Universal) en el tubo hasta que llegue al tope s sienta una ligera resistencia.

No fuerce el tubo y no pase las aletas.

Agarrando el cuerpo del PLASS4 con una llave apropiada, cierre firmamente el raccor con una llave (en las medidas 35-50 su raccor puede ser cerrado con un momento de 90 Nm). Arme la union de PE como en las instrucciones de los accesorios normales.

IMPORTANTE: no fuerce el tubo y pase el punto de resistencia. Puede danar el accesorio.

Comience apretar la tuerca al cuerpo. el cierre final hagalo con una llave PLASSON o similar. Ensamble la junta metrica como las instrucciones de un accesorio estandard.

Installation Instructions for Copper Pipe Adaptor



Instrucciones para la instalacion de adaptor tubo de cobre

Cut the copper pipe square and remove all burrs and sharp edges.

Twist the copper pipe into the fitting* through the rubber o-ring to the pipe stop.

Tighten the nut firmly. Use a wrench for final tightening. The nut should be closed tightly, however there is no need for the nut to actually meet the body shoulder.

Assemble the metric PE joint as per the standard fitting instructions.

* Lubrication of the pipe end will ease the insertion (use silicone lubricant).

Note: If reused, the metal grip ring must be replaced with a new one.

Corte el tubo a escuadra y elimine todas las virutas y cantos vivos.

Introduzca girando* el tubo de cobre junto con el o-ring hasta el tope.

Apriete la tuerca firmemente. use una llave para el apriete final. La tuerca debe estar apretada herméticamente. Sin embargo no es necesario que llegue hasta el borde del cuerpo.

Ensamble la junta metrica pe como un accesorio estandard.

* Para facilitar la introduccion utilice un lubricante a base de silicona.

NOTA: Si quiere reusar el accesorio debe reemplazar el agarre de metal por uno nuevo.